

CC ATEX

Aspiratori assiali intubati

Duct axial fan



Zona 21 II2D Ex h IIIB T 135°C Db
DUST



NORME | NORMS

EN 14986:2017
EN 1127-1
EN ISO 80079-36
EN ISO 80079-37

Attestato di Esame del Tipo Type Examination Statement



IMQ 10ATEX 019 X

A RICHIESTA UPON REQUEST

- Versioni a 60 Hz
- Classi di temperatura T5 e T6
- Girante con pale e fascia in alluminio antiscintilla
- Versions at 60 Hz
- Temperature classes T5 and T6
- Non-sparking aluminum impeller and band

DESCRIZIONE

Gli aspiratori assiali intubati della serie CC ATEX sono costruiti e certificati in conformità alla Direttiva ATEX 2014/34/UE. Sono specificatamente progettati per essere utilizzati in zona 21, ossia in aree o ambienti dove sia necessario garantire un elevato fattore di sicurezza contro le esplosioni dovute alla presenza di polveri combustibili (II2D). Il loro impiego è previsto per convogliare aria pulita con temperature comprese in un range da -20°C a +60°C (su richiesta, da -40°C a +60°C). Sono utilizzati in applicazioni canalizzate che necessitano di grandi portate d'aria con cadute di pressione non elevate, come ad esempio impianti di ventilazione e raffreddamento in ambito industriale, navale, commerciale, civile, energetico. Questa serie presenta, rispetto ai ventilatori centrifughi, il vantaggio di un minor ingombro e una maggiore facilità d'installazione.

CONSTRUZIONE

- Cassa in lamiera d'acciaio, con flange di fissaggio, realizzate a norma UNI ISO 13351:2010. Verniciata a polveri epossipoliestiriche.
- Girante con pale a profilo alare in nylon-vetro antistatico e mozzo in fusione di lega d'alluminio. Bilanciata secondo UNI ISO 21940-11:2017. Angolo di calettamento variabile da fermo (tramite tasselli di regolazione).
- Esecuzione 4 (accoppiamento diretto con girante) e flusso aria da motore a girante.

MOTORE

Motore antideflagrante asincrono trifase o monofase a norme internazionali IEC 60034, IEC 60072, ATEX 2014/34/UE, EMC 2014/30/UE, LVD 2014/35/UE, marcato CE, IP66 secondo la EN ISO 20653, classe F. Idoneo ad un servizio continuo (S1). Specificamente progettato per installazione in ambienti classificati come zona ATEX 21 II2D (POLVERI) IIIC, apparecchiature protette mediante custodie con requisiti di tenuta alla penetrazione della polvere "tb" in accordo allo standard CEI EN IEC 60079-0, CEI EN 60079-31. Motore dotato di sistema di protezione da sovratemperatura con termistori tipo PTC conformi alle norme DIN 44081, DIN 44082, IEC 60034-11-2 e idoneo alla regolazione di velocità a mezzo di regolatore tipo inverter (per la versione trifase).

ACCESSORI

- CCpro - Prolunga con portella d'ispezione
- CCR - Rete di protezione piana
- CCrc - Rete di protezione conica
- CCga - Giunto antivibrante
- CCst - Staffe di fissaggio
- CCbo - Bocchaglio in aspirazione/mandata
- CCsa e CCsb - Silenziatori con e senza ogiva con tre diverse lunghezze
- CCf - Controflange
- CCfc - Controflange con collare
- CCot - Terminale con rete
- Supporti antivibranti
- Scatola morsetti esterna a norme ATEX
- Interruttore di servizio ATEX.

DESCRIPTION

The ducted axial fans of the CC ATEX series are built and certified in compliance with the ATEX Directive 2014/34/UE. They are specifically designed to be used in zone 21, i.e. in areas or environments where it is necessary to guarantee a high safety factor against explosions due to the presence of combustible dusts (II2D). They are suitable to convey clean air with a temperature included in a range from -20°C to +60°C (on request, from -40°C to +60°C). CC fans are used for ducted installations requiring large airflow with relatively low pressure drop, like ventilation and cooling systems in industrial, naval, commercial, civil, energetic fields. This series has, compared to centrifugal fans, the advantage of being smaller in dimensions and easier to be installed.

CONSTRUCTION

- Short casing in steel sheet, with fixing flanges manufactured according to UNI ISO 13351:2010 standard. Protected against atmospheric agents by epoxy paint.
- Axial impeller with aerofoil profile blades in glass reinforce antistat polyamide and die-cast aluminium hub, balanced according ISO 21940-11:2017. Variable pitch angle in still position with setting means.
- Execution 4 (with impeller directly coupled to motor) and airflow from motor to impeller.

MOTOR

Explosion-proof asynchronous three-phase or single-phase motor compliant with international standards IEC 60034, IEC 60072, ATEX 2014/34/UE, EMC 2014/30/UE, LVD 2014/35/UE, CE marked, IP66 to EN ISO 20653, class F. Suitable for continuous service (S1). Specifically designed for installation in environments classified as ATEX zone 21 II2D (DUST) IIIC, equipment protected by enclosures with dust penetration tightness requirements "tb" according to CEI EN IEC 60079-0, CEI EN 60079-31. The motor includes an overtemperature protection system equipped with PTC thermistors in accordance with DIN 44081, DIN 44082, IEC 60034-11-2 and suitable for speed regulation by inverter-type controller (for three-phase version).

ACCESSORIES

- CCpro - Extension (for long casing version) with inspection porthole
- CCR - Flat protection guard
- CCrc - Conic protection guard
- CCga - Flexible connectors
- CCst - Support feet
- CCbo - Inlet/outlet bell mouth
- CCsa and CCsb - Silencers, with and without pod, in three lengths
- CCf - Counter flange
- CCfc - Counter flange with collar
- CCot - Outlet terminal
- Anti-vibration mounts
- External ATEX terminal box
- ATEX service switch.

VERSIONI | VERSIONS



CC ATEX
Zone 1
II2G Ex h IIIB T4 Gb
GAS



CC ATEX
Zone 1
II2G Ex IIIB+H2 T4 Gb
HYDROGEN

CASSA CORTA | SHORT CASING

I ventilatori della serie CC sono in esecuzione a cassa corta di standard, per semplicità d'installazione, movimentazione e contenimento dei costi. Quest'esecuzione è anche concepita per il montaggio nella parte iniziale o finale di una canalizzazione. In questo caso, una corretta installazione prevede l'utilizzo del bocchaglio "CCbo" (vedere accessori).

The CC fans series are in short casing execution as standard, for ease of transport and installation and for cost saving. This execution is also suitable for assembling in the initial or final part of a ducted system. In this case a correct installation foresees the use of the inlet/outlet bell mouth "CCbo" (see accessories).

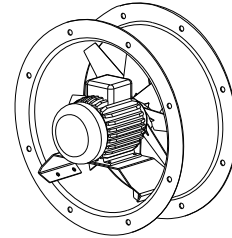

CASSA LUNGA | LONG CASING

I ventilatori della serie CC possono essere forniti in esecuzione a cassa lunga, con girante e motore completamente protetti dalla cassa, utilizzando la prolunga "CCpro" (vedere accessori). La prolunga "CCpro" è completa di portellina d'ispezione e fori per passaggio cavi.

The CC series fans can be provided in long casing execution, with impeller and motor completely protected inside the casing, by using the extension "CCpro" (see accessories). The extension "CCpro" is complete of inspection porthole and holes for cable entry.

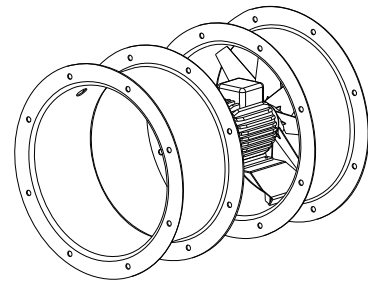

MULTISTADIO | MULTISTAGE

I ventilatori della serie CC, prevedono la possibilità d'esecuzioni multistadio, isorotanti o controrotanti (assemblaggio di due o più ventilatori monostadio con giranti rotanti nello stesso senso o in senso contrario). Queste configurazioni permettono di aumentare notevolmente la pressione sviluppata. In particolare la serie CC a due stadi controrotanti, sviluppa 2.5 volte la pressione sviluppata da un ventilatore monostadio, di pari diametro e velocità con un assorbimento di potenza non superiore alle 2 volte. Inoltre il ventilatore multistadio ha un rapporto prestazioni/livello sonoro vantaggioso, rispetto ad un ventilatore monostadio, potendo raggiungere le prestazioni richieste ad una minore velocità di rotazione.

The fans of the CC series foresee the possibility of multistage execution, iso-rotating or contra-rotating (assembly of two or more single-stage fans, with impellers rotating in the same or in the opposite direction). This configuration allows to considerably increase the pressure developed. Specifically, the CC series with two contra-rotating stages develops 2.5 times the pressure of a single-stage fan of equal diameter and speed, with a power absorption not bigger than 2 times. In addition, the multi-stage option, compared to the single-stage one, has a favourable relation performances/ noise, as the required performance can be achieved with a lower rotational speed.

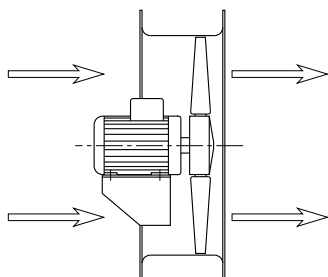
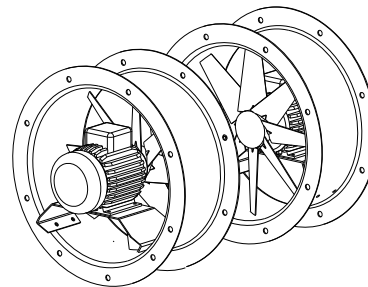

Flusso da MOTORE a GIRANTE (Orientamento standard)
Standard airflow from MOTOR to IMPELLER

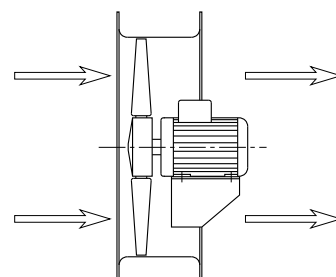

Flusso da GIRANTE a MOTORE (Orientamento a richiesta)
Upon request airflow from IMPELLER to motor

PRESTAZIONI | PERFORMANCE

CC ATEX 

Le prestazioni aerauliche sono rilevate in conformità alla norma EN ISO 5801/AMCA 210 con densità dell'aria standard avente peso specifico 1,2 Kg/m³. Il livello di potenza sonora è ottenuto secondo la norma AMCA 300-08 in camera riverberante. Installazione D.
Le tolleranze sono conformi alla ISO 13348 e alla DIN 24166. Alimentazione 230V/1Ph/50Hz o 400V/3Ph/50Hz.

Air performances are measured according to EN ISO 5801 / AMCA 210 standard with air density with 1.2 kg/m³ specific weight. The sound power level is obtained according to AMCA 300-08 in reverberating room. Installation D.
Tolerances comply with ISO13348 and DIN 24166. Power supply 230V/1Ph/50Hz or 400V/3Ph/50Hz.

NOTA

In questo catalogo è rappresentata una selezione delle prestazioni ottenibili con la **serie CC**, in grado di risolvere un elevato numero di problematiche aerauliche. La scelta ha lo scopo di coniugare costo/prestazioni e tempi di consegna. A richiesta il nostro servizio tecnico è in grado di configurare apparecchi per numerose differenti esigenze.

NOTE

In this catalogue is represented a selection of performances achievable with the **CC series**, capable of solving a large number of aeraulic problems. The choice aims to combine cost/performance and delivery time. On request, our technical service is able to configure devices for numerous different requirements

CC ATEX 310

Cod.	Tipo Type	Modello Model	U	P	Pm (kW)	In (A)	IP/CL	IE3	Mot. (Gr)
1XC0000		312	M	2	0,25	2,20	66/F	-	71
1XC0012		312	T	2	0,25	0,62	66/F	-	63
1XC0001	CC - ATX	314-A	M	4	0,12	1,20	66/F	-	63
1XC0013		314-A	T	4	0,12	0,51	66/F	-	63
1XC0002		314-B	M	4	0,12	1,20	66/F	-	63
1XC0014		314-B	T	4	0,12	0,51	66/F	-	63

Attenzione: non utilizzare le versioni a 2 poli nelle applicazioni a bocca libera o con modeste perdite di carico!

Caution: do not use 2 poles version in free inlet application or with small charge losses!

LIVELLI SONORI | SOUND LEVELS dB(A)

Hz		62,5	125	250	500	1000	2000	4000	8000	TOT
312	LwA	56	67	83	81	82	80	77	72	88
	Lp	35	46	62	60	61	59	56	51	67
314-A	LwA	42	60	63	67	68	66	63	58	73
	Lp	21	39	42	46	47	45	42	37	52
314-B	LwA	33	51	53	58	59	57	54	49	63
	Lp	12	30	32	37	38	36	33	28	42

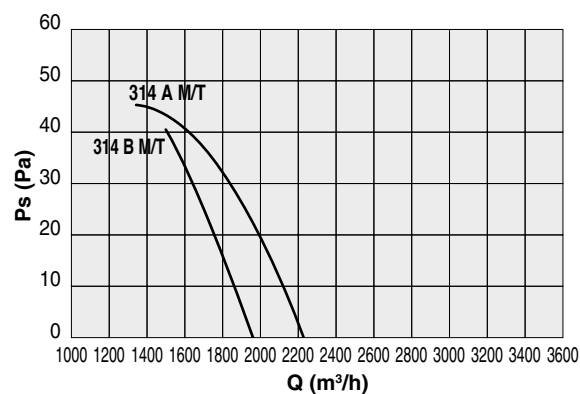
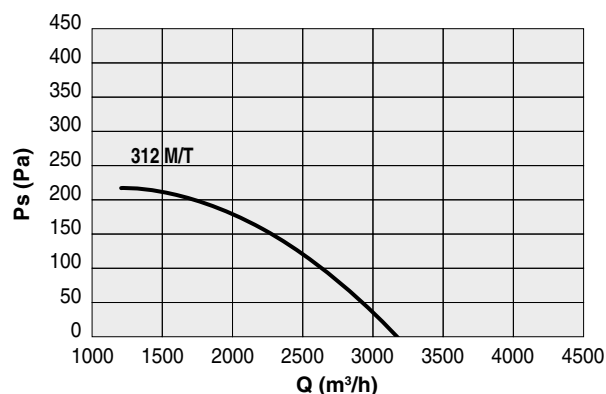

CC ATEX 350

Code	Tipo Type	Modello Model	U	P	Pm (kW)	In (A)	IP/CL	IE3	Mot. (Gr)
1XC0003		352	M	2	0,55	3,79	66/F	-	80
1XC0015		352	T	2	0,55	1,50	66/F	-	71
1XC0004	CC ATX	354-A	M	4	0,12	1,20	66/F	-	63
1XC0016		354-A	T	4	0,12	0,51	66/F	-	63
1XC0005		354-B	M	4	0,12	1,20	66/F	-	63
1XC0017		354-B	T	4	0,12	0,51	66/F	-	63

Attenzione: non utilizzare le versioni a 2 poli nelle applicazioni a bocca libera o con modeste perdite di carico!

Caution: do not use 2 poles version in free inlet application or with small charge losses!

LIVELLI SONORI | SOUND LEVELS dB(A)

Hz		62,5	125	250	500	1000	2000	4000	8000	TOT
352	LwA	57	68	85	82	83	81	78	73	89
	Lp	36	47	64	61	62	60	57	52	68
354-A	LwA	46	64	66	71	72	70	67	62	76
	Lp	25	43	45	50	51	49	46	41	55
354-B	LwA	37	55	58	62	63	61	58	53	68
	Lp	16	34	37	41	42	40	37	32	47

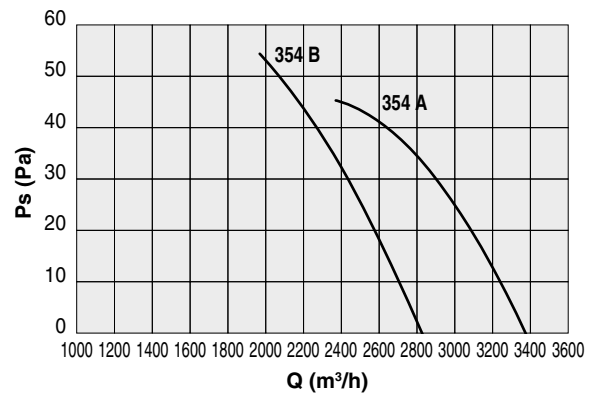
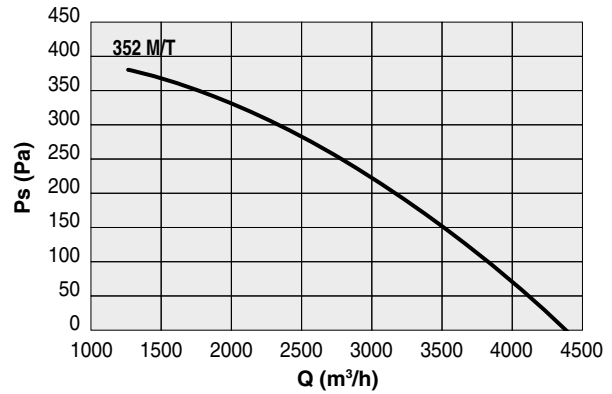

CC ATEX 400

Code	Tipo Type	Modello Model	U	P	Pm (kW)	In (A)	IP/CL	IE3	Mot. (Gr)
1XC0006		402	M	2	1,10	7,60	66/F	-	90
1XC0018		402	T	2	1,10	2,40	66/F	✓	80
1XC0007	CC ATX	404-A	M	4	0,18	1,75	66/F	-	71
1XC0019		404-A	T	4	0,18	0,70	66/F	-	63
1XC0008		404-B	M	4	0,18	1,75	66/F	-	71
1XC0020		404-B	T	4	0,18	0,70	66/F	-	63

Attenzione: non utilizzare le versioni a 2 poli nelle applicazioni a bocca libera o con modeste perdite di carico!

Caution: do not use 2 poles version in free inlet application or with small charge losses!

LIVELLI SONORI | SOUND LEVELS dB(A)

Hz		62,5	125	250	500	1000	2000	4000	8000	TOT
402	LwA	60	71	87	85	86	84	81	76	91
	Lp	39	50	66	64	65	63	60	55	70
404-A	LwA	50	68	70	75	76	74	71	66	80
	Lp	29	47	49	54	55	53	50	45	59
404-B	LwA	42	60	63	67	68	66	63	58	73
	Lp	21	39	42	46	47	45	42	37	52

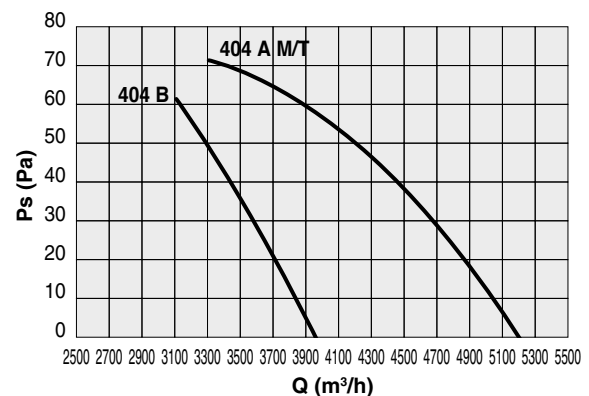
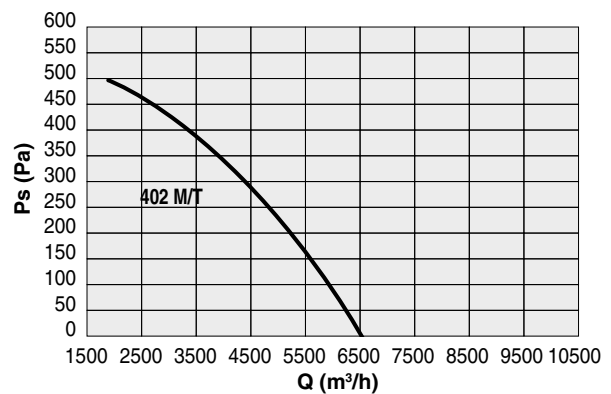

CC ATEX 450

Code	Tipo Type	Modello Model	U	P	Pm (kW)	In (A)	IP/CL	IE3	Mot. (Gr)
1XC0021		452	T	2	1,50	3,40	66/F	✓	90
1XC0009		454-A	M	4	0,37	2,66	66/F	-	71
1XC0022		454-A	T	4	0,37	1,10	66/F	-	71
1XC0010	CC ATX	454-B	M	4	0,37	2,66	66/F	-	71
1XC0023		454-B	T	4	0,37	1,10	66/F	-	71
1XC0011		454-C	M	4	0,18	1,75	66/F	-	63
1XC0024		454-C	T	4	0,18	0,70	66/F	-	63

Attenzione: non utilizzare le versioni a 2 poli nelle applicazioni a bocca libera o con modeste perdite di carico!

Caution: do not use 2 poles version in free inlet application or with small charge losses!

LIVELLI SONORI | SOUND LEVELS dB(A)

Hz		62,5	125	250	500	1000	2000	4000	8000	TOT
452	LwA	60	71	88	85	86	84	81	76	92
	Lp	39	50	67	64	65	63	60	55	71
454-A	LwA	47	65	67	72	73	71	68	63	78
	Lp	26	44	46	51	52	50	47	42	57
454-B	LwA	45	63	65	70	72	69	66	51	75
	Lp	24	42	44	49	50	48	45	40	54
454-C	LwA	44	62	64	69	70	68	65	60	74
	Lp	23	41	43	48	49	47	44	39	53

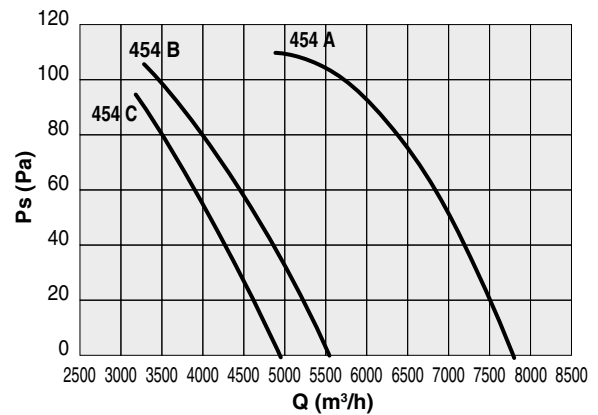
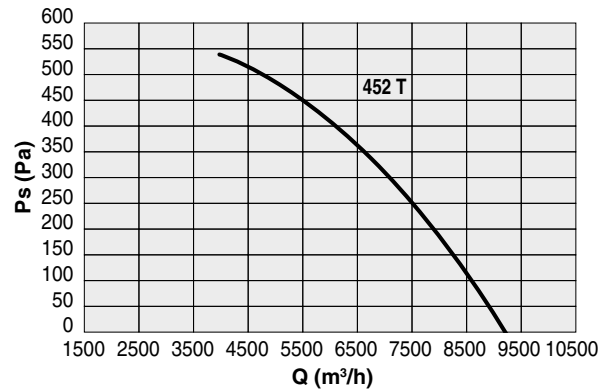

CC ATEX 500

Code	Tipo Type	Modello Model	U	P	Pm (kW)	In (A)	IP/CL	IE3	Mot. (Gr)
1XC0025		504-A	T	4	0,55	1,50	66/F	-	80
1XC0026		504-B	T	4	0,55	1,50	66/F	-	80
1XC0027	CC ATX	506	T	6	0,18	0,76	66/F	-	71
1XC0028		508	T	8	0,18	0,95	66/F	-	80

LIVELLI SONORI | SOUND LEVELS dB(A)

Hz		62,5	125	250	500	1000	2000	4000	8000	TOT
504-A	LwA	56	74	76	81	82	80	77	72	86
	Lp	35	53	55	60	61	59	56	51	65
504-B	LwA	47	65	68	72	73	71	68	63	78
	Lp	26	44	47	51	52	50	47	42	57
506	LwA	46	64	66	71	72	70	67	62	76
	Lp	25	43	45	50	51	49	46	41	55
508	LwA	45	49	59	63	64	62	59	54	69
	Lp	24	28	38	42	43	41	38	33	48

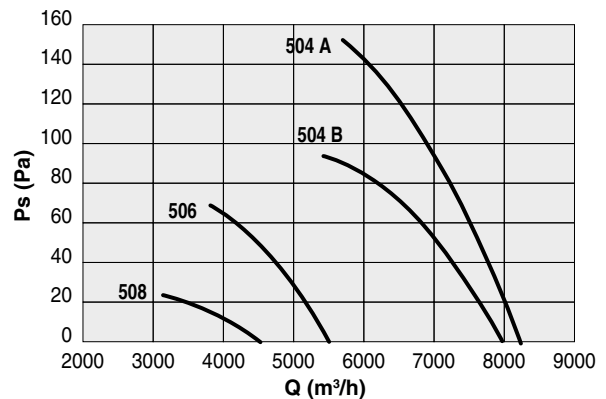

CC ATEX 560

Code	Tipo Type	Modello Model	U	P	Pm (kW)	In (A)	IP/CL	IE3	Mot. (Gr)
1XC0029	CC ATX	564-A	T	4	0,75	2,00	66/F	✓	80
1XC0030		564-B	T	4	0,75	2,00	66/F	✓	80
1XC0031		566	T	6	0,25	1,00	66/F	-	71
1XC0032		568	T	8	0,18	0,95	66/F	-	80

LIVELLI SONORI | SOUND LEVELS dB(A)

Hz		62,5	125	250	500	1000	2000	4000	8000	TOT
564-A	LwA	54	65	81	79	80	78	75	70	85
	Lp	33	44	60	58	59	57	54	49	64
564-B	LwA	54	65	81	79	80	78	75	70	86
	Lp	33	44	60	58	59	57	54	49	65
566	LwA	43	61	64	68	69	67	64	59	74
	Lp	22	40	43	47	48	46	43	38	53
568	LwA	43	47	56	61	62	60	57	52	66
	Lp	22	26	35	40	41	39	36	31	45

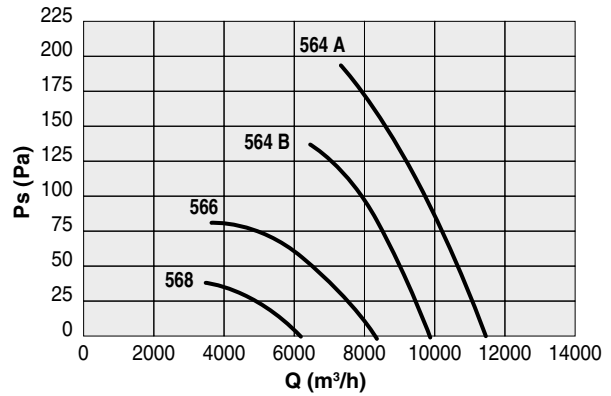

CC ATEX 630

Code	Tipo Type	Modello Model	U	P	Pm (kW)	In (A)	IP/CL	IE3	Mot. (Gr)
1XC0033	CC ATX	634-A	T	4	1,10	2,70	66/F	✓	90S
1XC0034		634-B	T	4	1,10	2,70	66/F	✓	90S
1XC0035		636	T	6	0,37	1,25	66/F	-	80
1XC0036		638	T	8	0,18	0,95	66/F	-	80

LIVELLI SONORI | SOUND LEVELS dB(A)

Hz		62,5	125	250	500	1000	2000	4000	8000	TOT
634-A	LwA	58	76	78	83	84	82	79	74	88
	Lp	37	55	57	62	63	61	58	53	67
634-B	LwA	55	73	75	80	81	79	76	71	85
	Lp	34	52	54	59	60	58	55	50	64
636	LwA	49	67	69	74	75	73	70	65	79
	Lp	28	46	48	53	54	52	49	44	58
638	LwA	49	53	63	67	68	66	63	58	73
	Lp	28	32	42	46	47	45	42	37	52

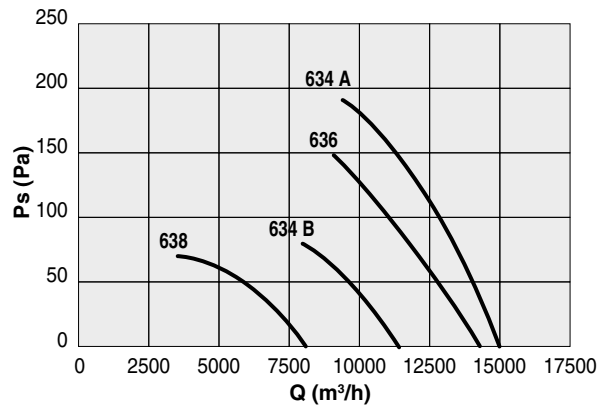

CC ATEX 710

Code	Tipo Type	Modello Model	U	P	Pm (kW)	In (A)	IP/CL	IE3	Mot. (Gr)
1XC0037	CC ATX	714-A	T	4	2,20	5,50	66/F	✓	100L
1XC0038		714-B	T	4	2,20	5,50	66/F	✓	100L
1XC0039		716	T	6	0,75	2,70	66/F	✓	90S
1XC0040		718	T	8	0,37	1,30	66/F	-	90S

LIVELLI SONORI | SOUND LEVELS dB(A)

Hz		62,5	125	250	500	1000	2000	4000	8000	TOT
714-A	LwA	66	77	93	91	92	90	87	82	98
	Lp	45	56	72	70	71	69	66	61	77
714-B	LwA	56	67	83	81	82	80	77	72	88
	Lp	35	46	62	60	61	59	56	51	67
716	LwA	56	74	77	81	82	80	77	72	87
	Lp	35	53	56	60	61	59	56	51	66
718	LwA	57	61	71	75	76	74	71	66	81
	Lp	36	40	50	54	55	53	50	45	60

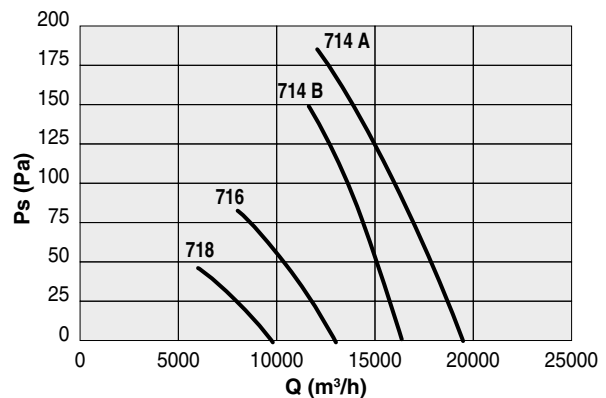

CC ATEX 800 - 4 poli

Code	Tipo Type	Modello Model	U	P	Pm (kW)	In (A)	IP/CL	IE3	Mot. (Gr)
1XC0041		804-A	T	4	5,50	11,94	66/F	✓	132
1XC0042	CC ATX	804-B	T	4	4,00	8,80	66/F	-	112M
1XC0043		804-C	T	4	3,00	6,55	66/F	-	100L

LIVELLI SONORI | SOUND LEVELS dB(A)

Hz		62,5	125	250	500	1000	2000	4000	8000	TOT
804-A	LwA	62	73	90	87	88	86	83	78	94
	Lp	41	52	69	66	67	65	62	57	73
804-B	LwA	64	75	91	89	90	88	85	80	96
	Lp	43	54	70	68	69	67	64	59	75
804-C	LwA	65	76	93	90	91	89	86	81	97
	Lp	44	55	72	69	70	68	65	60	76

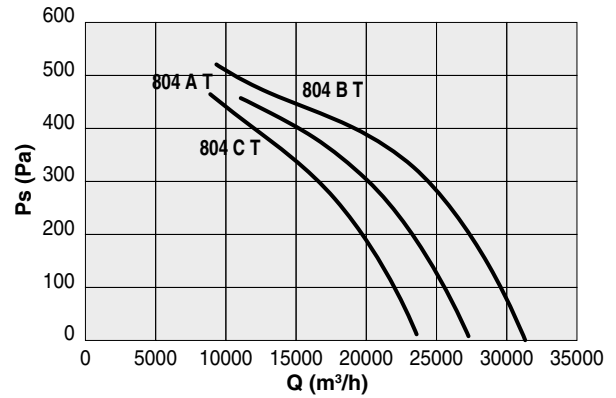

CC ATEX 800 - 6 poli

Code	Tipo Type	Modello Model	U	P	Pm (kW)	In (A)	IP/CL	IE3	Mot. (Gr)
1XC0044		806-A	T	6	1,50	3,80	66/F	-	100L
1XC0045	CC ATX	806-B	T	6	1,10	2,70	66/F	-	90L
1XC0046		806-C	T	6	0,75	2,70	66/F	-	90L

LIVELLI SONORI | SOUND LEVELS dB(A)

Hz		62,5	125	250	500	1000	2000	4000	8000	TOT
806-A	LwA	52	70	73	77	78	76	73	68	83
	Lp	31	49	52	56	57	55	52	47	62
806-B	LwA	54	72	74	79	80	78	75	70	84
	Lp	33	51	53	58	59	57	54	49	63
806-C	LwA	56	74	76	81	82	80	77	72	86
	Lp	35	53	55	60	61	59	56	51	65

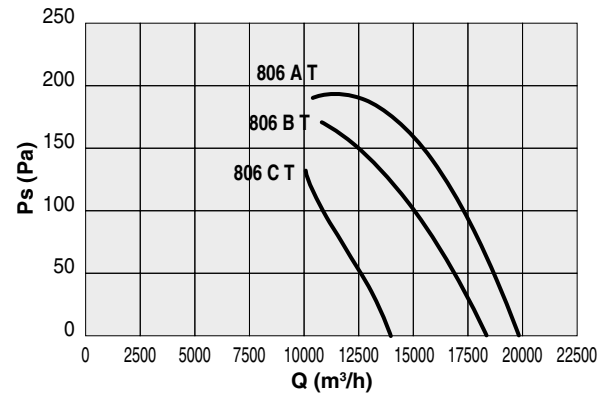

CC ATEX 800 - 8 poli

Code	Tipo Type	Modello Model	U	P	Pm (kW)	In (A)	IP/CL	IE3	Mot. (Gr)
1XC0047		808-A	T	8	0,55	1,85	66/F	-	90L
1XC0048	CC ATX	808-B	T	8	0,55	1,85	66/F	-	90L
1XC0049		808-C	T	8	0,37	1,30	66/F	-	90L

LIVELLI SONORI | SOUND LEVELS dB(A)

Hz		62,5	125	250	500	1000	2000	4000	8000	TOT
808-A	LwA	53	57	66	71	72	70	67	62	76
	Lp	32	36	45	50	51	49	46	41	55
808-B	LwA	55	59	68	73	74	72	69	64	78
808-B	Lp	34	38	47	52	53	51	48	43	57
808-C	LwA	57	61	70	75	76	74	71	66	80
808-C	Lp	36	40	49	54	55	53	50	45	59

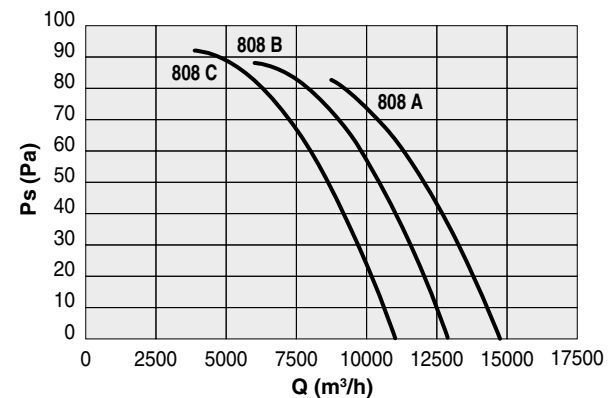

PRESTAZIONI | PERFORMANCE

CC ATEX 

CC ATEX 900 - 4 poli

Code	Tipo Type	Modello Model	U	P	Pm (kW)	In (A)	IP/CL	IE3	Mot. (Gr)
1XC0050		904-A	T	4	9,00	17,50	66/F	✓	132M
1XC0051	CC ATX	904-B	T	4	7,50	14,40	66/F	✓	132M
1XC0052		904-C	T	4	5,50	11,94	66/F	✓	132S

LIVELLI SONORI | SOUND LEVELS dB(A)

Hz		62,5	125	250	500	1000	2000	4000	8000	TOT
904-A	LwA	68	79	96	93	94	92	89	84	100
	Lp	47	58	75	72	73	71	68	63	79
904-B	LwA	67	78	94	92	93	91	88	83	99
	Lp	46	57	73	71	72	70	67	62	78
904-C	LwA	63	74	90	88	89	87	84	79	95
	Lp	42	53	69	67	68	66	63	58	74

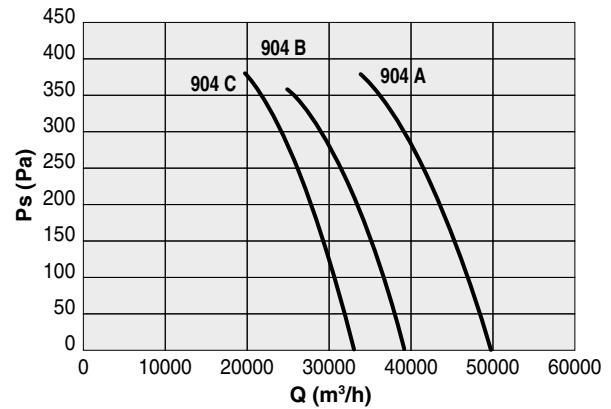

CC ATEX 900 - 6 poli

Code	Tipo Type	Modello Model	U	P	Pm (kW)	In (A)	IP/CL	IE3	Mot. (Gr)
1XC0053		906-A	T	6	3,00	6,75	66/F	✓	132M
1XC0054	CC ATX	906-B	T	6	2,20	5,40	66/F	✓	112M
1XC0055		906-C	T	6	1,50	3,80	66/F	✓	100M

LIVELLI SONORI | SOUND LEVELS dB(A)

Hz		62,5	125	250	500	1000	2000	4000	8000	TOT
906-A	LwA	59	77	79	84	85	83	80	75	89
	Lp	38	56	58	63	64	62	59	54	68
906-B	LwA	58	76	78	83	84	82	79	74	88
	Lp	37	55	57	62	63	61	58	53	67
906-C	LwA	56	74	76	81	82	80	77	72	86
	Lp	35	53	55	60	61	59	56	51	65

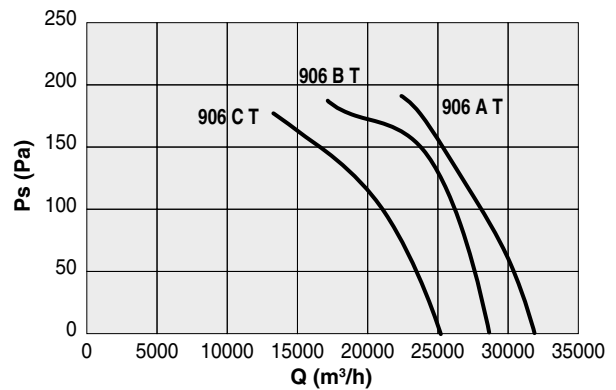

CC ATEX 900 - 8 poli

Code	Tipo Type	Modello Model	U	P	Pm (kW)	In (A)	IP/CL	IE3	Mot. (Gr)
1XC0056		908-A	T	8	1,50	4,30	66/F	✓	112M
1XC0057	CC ATX	908-B	T	8	1,10	3,00	66/F	✓	100L
1XC0058		908-C	T	8	1,10	3,00	66/F	✓	100L

LIVELLI SONORI | SOUND LEVELS dB(A)

Hz		62,5	125	250	500	1000	2000	4000	8000	TOT
908-A	LwA	53	71	73	78	79	77	74	69	83
	Lp	32	50	52	57	58	56	53	48	62
908-B	LwA	51	69	71	76	77	75	72	67	81
	Lp	30	48	50	55	56	54	51	46	60
908-C	LwA	49	67	69	74	75	73	70	65	79
	Lp	28	46	48	53	54	52	49	44	58

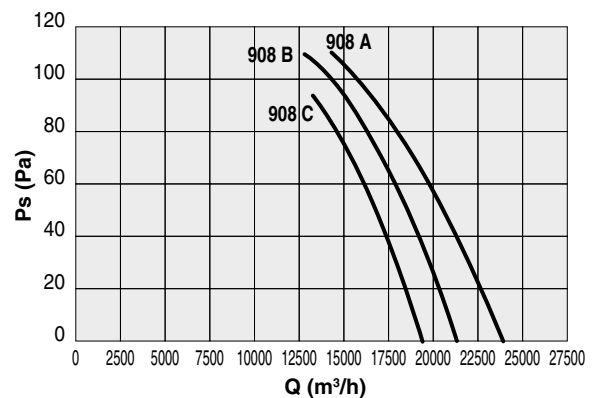

CC ATEX 1000 - 4 poli

Code	Tipo Type	Modello Model	U	P	Pm (kW)	In (A)	IP/CL	IE3	Mot. (Gr)
1XC0059		1004-A	T	4	15,00	27,95	66/F	✓	160L
1XC0060	CC ATX	1004-B	T	4	11,00	21,97	66/F	✓	160M
1XC0061		1004-C	T	4	7,50	14,40	66/F	✓	132M

LIVELLI SONORI | SOUND LEVELS dB(A)

Hz		62,5	125	250	500	1000	2000	4000	8000	TOT
1004-A 15 kW	LwA	79	90	107	104	105	103	100	95	111
	Lp	58	69	86	83	84	82	79	74	90
1004-B 11kW	LwA	73	84	101	98	99	97	94	89	105
	Lp	52	63	80	77	78	76	73	68	84
1004-C 7,5kW	LwA	66	77	94	91	92	90	87	82	98
	Lp	45	56	73	70	71	69	66	61	77

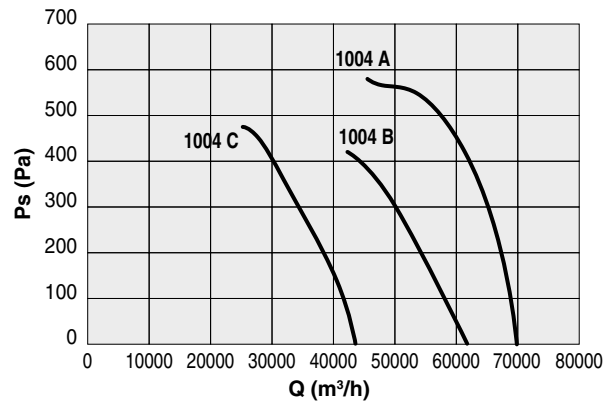

CC ATEX 1000 - 6 poli

Code	Tipo Type	Modello Model	U	P	Pm (kW)	In (A)	IP/CL	IE3	Mot. (Gr)
1XC0062		1006-A	T	6	5,50	11,50	66/F	✓	132M
1XC0063	CC ATX	1006-B	T	6	4,00	8,64	66/F	✓	132M
1XC0064		1006-C	T	6	3,00	6,75	66/F	✓	132S

LIVELLI SONORI | SOUND LEVELS dB(A)

Hz		62,5	125	250	500	1000	2000	4000	8000	TOT
1006-A	LwA	61	79	82	86	87	85	82	77	92
	Lp	40	58	61	65	66	64	61	56	71
1006-B	LwA	64	82	84	89	90	88	85	80	95
	Lp	43	61	63	68	69	67	64	59	74
1006-C	LwA	57	75	77	82	83	81	78	73	87
	Lp	36	54	56	61	62	60	57	52	66

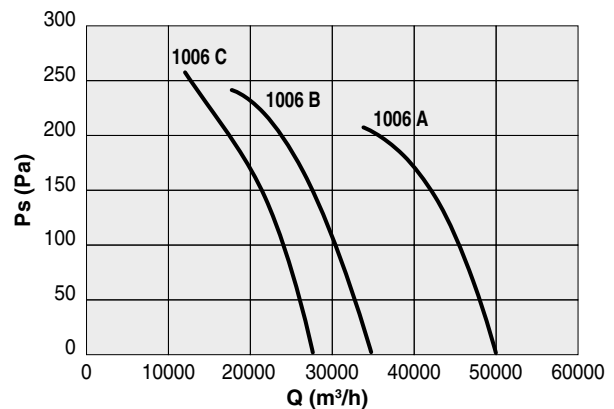

CC ATEX 1000 - 8 poli

Code	Tipo Type	Modello Model	U	P	Pm (kW)	In (A)	IP/CL	IE3	Mot. (Gr)
1XC0065		1008-A	T	8	2,20	5,20	66/F	✓	132S
1XC0066	CC ATX	1008-B	T	8	1,50	4,30	66/F	✓	112M
1XC0067		1008-C	T	8	1,10	3,00	66/F	✓	100L

LIVELLI SONORI | SOUND LEVELS dB(A)

Hz		62,5	125	250	500	1000	2000	4000	8000	TOT
1008-A	LwA	55	73	76	80	81	79	76	71	86
	Lp	34	52	55	59	60	58	55	50	65
1008-B	LwA	58	76	78	83	84	82	79	74	88
	Lp	37	55	57	62	63	61	58	53	67
1008-C	LwA	50	68	71	75	76	74	71	66	81
	Lp	29	47	50	54	55	53	50	45	60

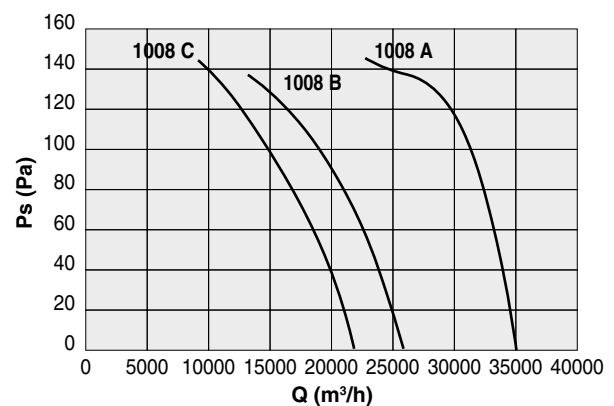

CC ATEX 1120 - 6 poli

Code	Tipo Type	Modello Model	U	P	Pm (kW)	In (A)	IP/CL	IE3	Mot. (Gr)
1XC0068		1126-5Z-8-45	T	6	7,50	15,90	66/F	✓	160M
1XC0069	CC ATEX	1126-5Z-8-38,5	T	6	5,50	11,50	66/F	✓	132M
1XC0070		1126-5Z-8-33,5	T	6	4,00	8,64	66/F	✓	132M

LIVELLI SONORI | SOUND LEVELS dB(A)

Hz		62,5	125	250	500	1000	2000	4000	8000	TOT
1126 7,5 kW	LwA	64	82	85	89	90	89	86	81	95
	Lp	43	61	64	68	69	68	65	60	74
1126 5,5 kW	LwA	67	85	88	92	93	92	89	84	98
	Lp	46	64	67	71	72	71	68	63	77
1126 4,0 kW	LwA	58	76	79	83	84	83	80	75	89
	Lp	37	55	58	62	63	62	59	54	68

CC ATEX 1120 - 8 poli

Code	Tipo Type	Modello Model	U	P	Pm (kW)	In (A)	IP/CL	IE3	Mot. (Gr)
1XC0071		1128-5Z-8-41,5	T	8	3,00	7,00	66/F	✓	132M
1XC0072	CC ATEX	1128-5Z-8-36	T	8	2,20	5,20	66/F	✓	132S

LIVELLI SONORI | SOUND LEVELS dB(A)

Hz		62,5	125	250	500	1000	2000	4000	8000	TOT
1128 3,0 kW	LwA	57	75	78	82	83	82	79	74	88
	Lp	36	54	57	61	62	61	58	53	67
1128 2,2 kW	LwA	61	79	81	86	87	86	83	78	92
	Lp	40	58	60	65	66	65	62	57	71

CC ATEX 1250 - 6 poli

Code	Tipo Type	Modello Model	U	P	Pm (kW)	In (A)	IP/CL	IE3	Mot. (Gr)
1XC0073		1256-6W-4-36	T	6	11,00	23,50	66/F	✓	160L
1XC0074	CC ATEX	1256-6W-4-33	T	6	7,50	15,90	66/F	✓	160M
1XC0075		1256-6W-4-29	T	6	5,50	11,50	66/F	✓	132M

LIVELLI SONORI | SOUND LEVELS dB(A)

Hz		62,5	125	250	500	1000	2000	4000	8000	TOT
1256 11 kW	LwA	73	91	94	98	99	98	95	90	104
	Lp	52	70	73	77	78	77	74	69	83
1256 7,5 kW	LwA	68	86	88	93	94	93	90	85	99
	Lp	47	65	67	72	73	72	69	64	78
1256 5,5 kW	LwA	63	81	84	88	89	88	85	80	94
	Lp	42	60	63	67	68	67	64	59	73

CC ATEX 1250 - 8 poli

Code	Tipo Type	Modello Model	U	P	Pm (kW)	In (A)	IP/CL	IE3	Mot. (Gr)
1XC0076		1258-6W-4-36	T	8	4,00	9,00	66/F	✓	160M
1XC0077	CC ATEX	1258-6W-4-31	T	8	3,00	7,00	66/F	✓	132M
1XC0078		1258-6W-4-27	T	8	2,20	5,20	66/F	✓	132S

LIVELLI SONORI | SOUND LEVELS dB(A)

Hz		62,5	125	250	500	1000	2000	4000	8000	TOT
1258 4,0 kW	LwA	67	85	87	92	93	92	89	84	97
	Lp	46	64	66	71	72	71	68	63	76
1258 3,0 kW	LwA	61	79	82	86	87	86	83	78	92
	Lp	40	58	61	65	66	65	62	57	71
1258 2,2 kW	LwA	57	75	78	82	83	82	79	74	88
	Lp	36	54	57	61	62	61	58	53	67

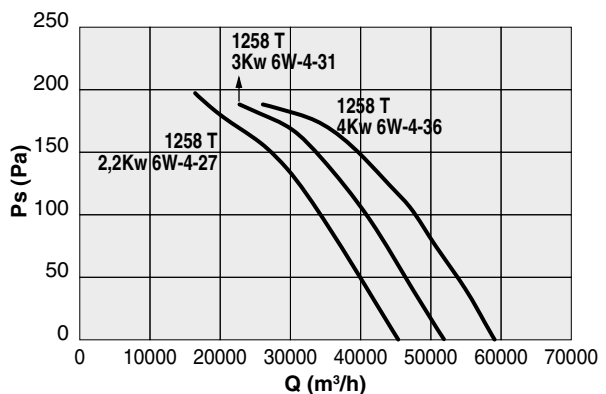
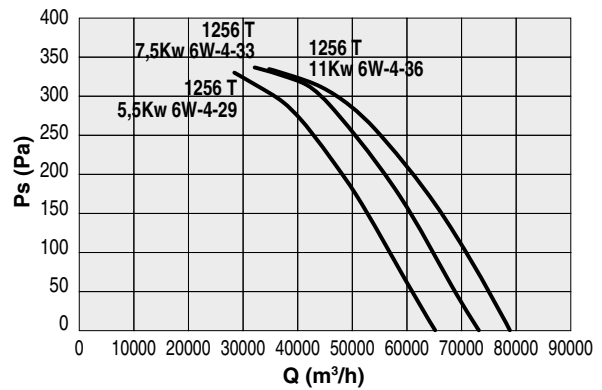
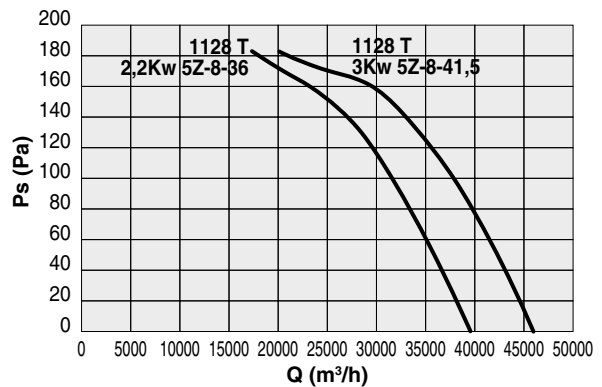
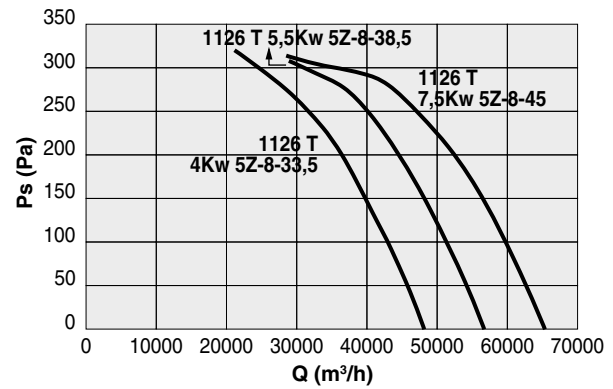

CC ATEX 1400

Code	Tipo Type	Modello Model	U	P	Pm (kW)	In (A)	IP/CL	IE3	Mot. (Gr)
1XC0079	CC ATX	1406-6W-5-32	T	6	15	29,00	66/F	✓	180L
1XC0080		1406-6W-5-28	T	6	11	23,50	66/F	✓	160L
1XC0081		1408-6W-5-35	T	8	7,5	15,90	66/F	✓	160L
1XC0082		1408-6W-5-29	T	8	5,5	12,30	66/F	✓	160M

LIVELLI SONORI | SOUND LEVELS dB(A)

Hz		62,5	125	250	500	1000	2000	4000	8000	TOT
1406-T 15 kW	LwA	75	83	88	93	95	96	96	90	102
	Lp	67	75	80	85	87	88	88	82	94
1406-T 11 kW	LwA	74	82	87	92	94	94	94	88	100
	Lp	66	74	79	84	86	86	86	80	92
1408-T 7,5 kW	LwA	74	81	86	91	93	94	94	88	100
	Lp	66	73	78	83	85	86	86	80	92
1408-T 5,5 kW	LwA	69	76	81	85	88	88	89	82	94
	Lp	59	67	73	78	81	81	82	75	87

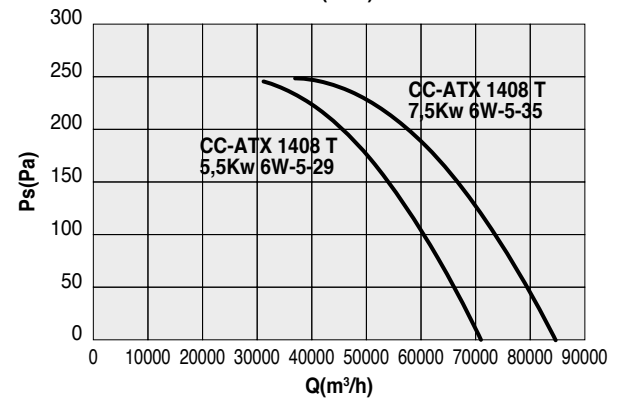
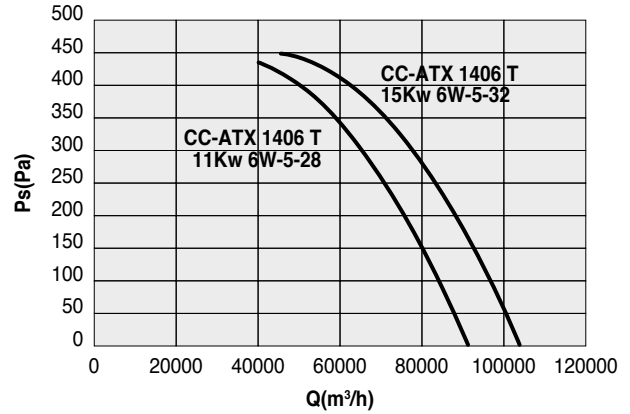

CC ATEX 1600

Code	Tipo Type	Modello Model	U	P	Pm (kW)	In (A)	IP/CL	IE3	Mot. (Gr)
1XC0083	CC ATX	1606-9W-5-31	T	6	22	44,00	66/F	✓	200L
1XC0084		1606-9W-5-26	T	6	15	29,00	66/F	✓	180L
1XC0085		1608-A-9W-5-33	T	8	11	22,00	66/F	✓	180L
1XC0086		1608-B-9W-5-27	T	8	7,5	15,90	66/F	✓	160L

LIVELLI SONORI | SOUND LEVELS dB(A)

Hz		62,5	125	250	500	1000	2000	4000	8000	TOT
1606-T 22 kW	LwA	80	87	92	96	99	99	98	91	105
	Lp	72	79	84	88	91	91	90	83	97
1606-T 15 kW	LwA	78	85	90	94	97	98	96	89	103
	Lp	70	77	82	86	89	90	88	81	95
1608-T 11 kW	LwA	77	84	89	93	96	97	96	88	102
	Lp	69	76	81	85	88	89	88	80	94
1608-T 7,5 kW	LwA	72	79	84	89	92	93	92	84	98
	Lp	64	71	76	81	84	85	84	76	90

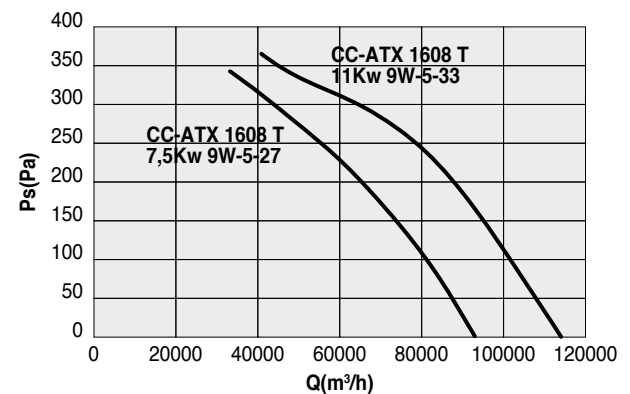
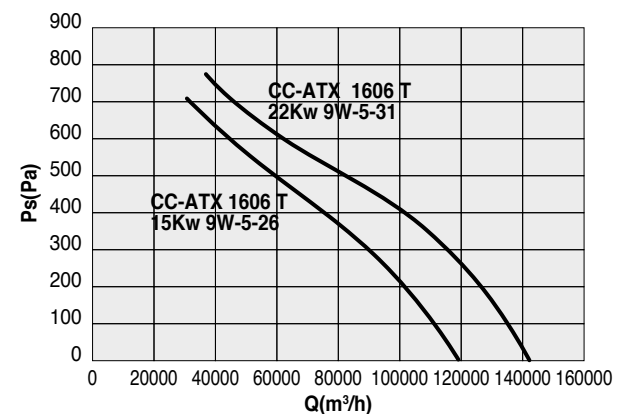

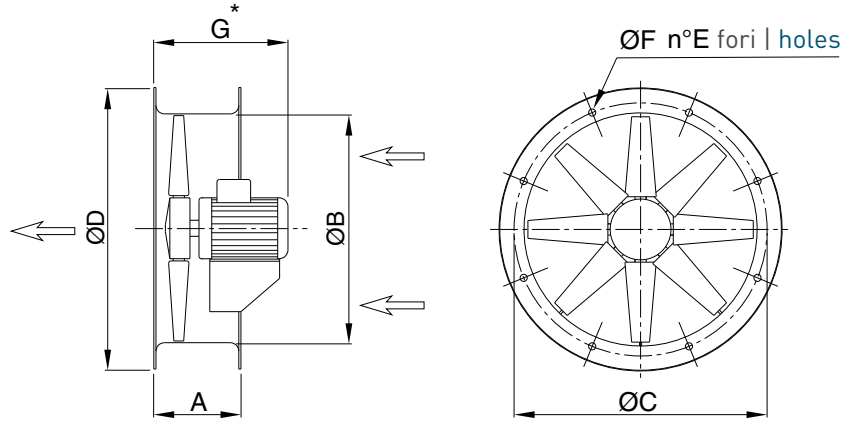

CC ATEX

TIPO TYPE	A	ØB	ØC	ØD	E	ØF	G*	Kg
CC ATX 31	200	305	355	395	8	10	380	24
CC ATX 35	200	355	395	446	8	10	380	27
CC ATX 40	230	405	450	496	8	12	430	32
CC ATX 45	230	455	500	546	8	12	430	40
CC ATX 50	250	505	560	598	12	12	440	41
CC ATX 56	250	565	620	658	12	12	440	44
CC ATX 63	250	635	690	730	12	12	500	55
CC ATX 71	250	708	770	810	16	12	520	70
CC ATX 80	350	808	860	910	16	12	590	135
CC ATX 90	350	908	970	1030	16	16	680	195
CC ATX 100	350	1010	1070	1130	16	16	750	232
CC ATX 112	350	1130	1190	1250	20	16	750	247
CC ATX 125	350	1260	1320	1380	20	16	750	278
CC ATX 140	450	1415	1470	1540	20	16	960	500
CC ATX 160	450	1615	1680	1730	24	18	940	790

Pesi indicativi | **Indicative weights**

*Quota indicativa, variabile in funzione della marca del motore | ***Indicative quote, variable according to the motor supplier.**

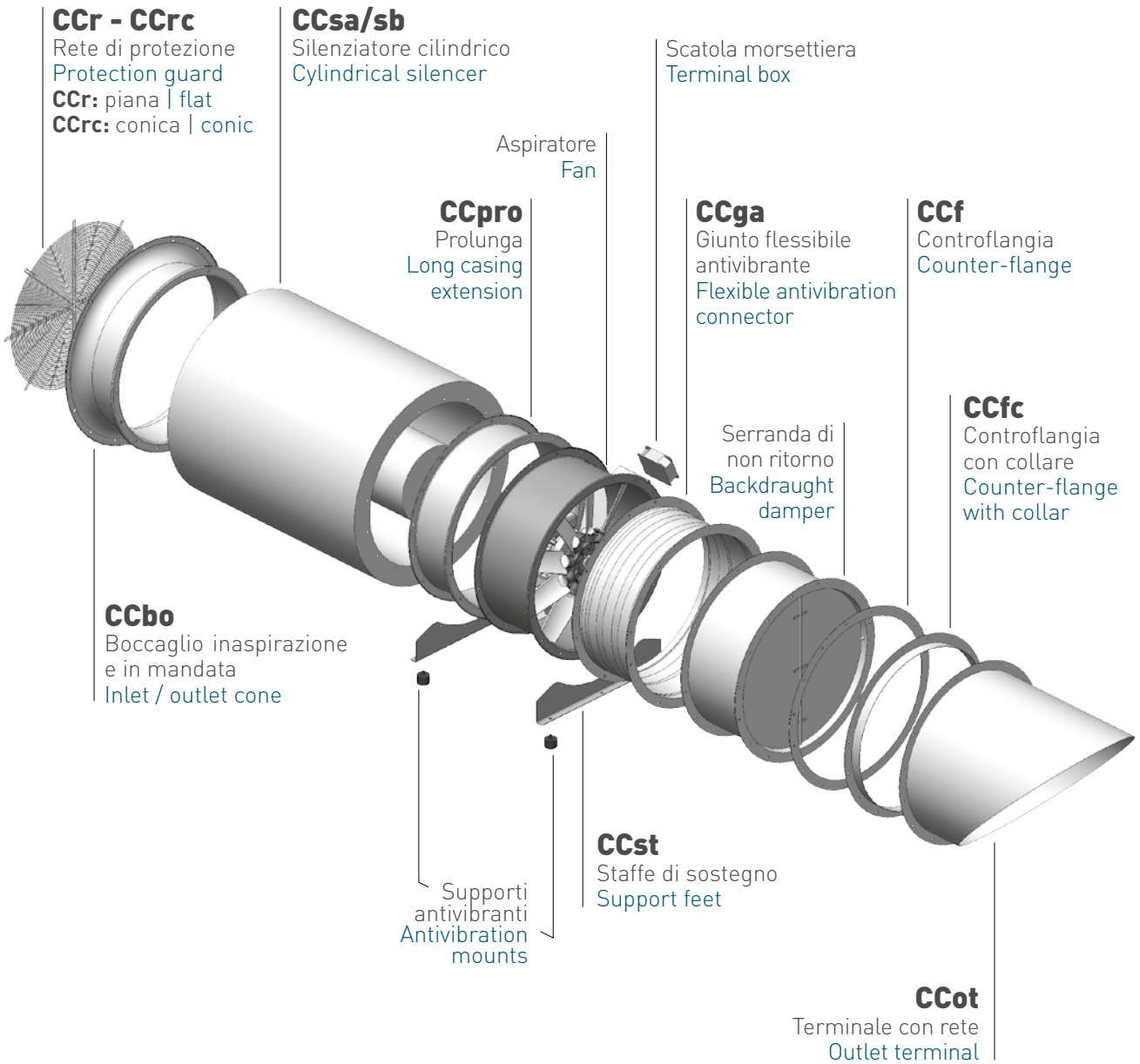



CCr - CCrc | RETI PROTEZIONE | PROTECTION GUARDS

Salvaguardano dal contatto accidentale con le parti in movimento del ventilatore. Realizzate in filo d'acciaio, a norma UNI 12499 e protette contro gli agenti atmosferici.
CCr: versione piana (per cassa lunga e cassa corta lato girante).
CCrc: versione conica (cassa corta lato motore).

They prevent from casual contact with moving parts of the fan. Manufactured in steel rod according to UNI 12499 standard and protected against atmospheric agents.

CCr: flat version (for long case and short case on impeller side).

CCrc: conic version (short case version on motor side).

CCr

Code	Tipo Type	ØA	Kg
5RE9031	CCr 31	355	0,6
5RE9035	CCr 35	395	0,7
5RE9040	CCr 40	450	0,8
5RE9045	CCr 45	500	1,0
5RE9050	CCr 50	560	1,3
5RE9056	CCr 56	620	1,6
5RE9063	CCr 63	690	1,9
5RE9071	CCr 71	770	2,2
5RE9080	CCr 80	860	3,0
5RE9090	CCr 90	970	3,4
5RE9100	CCr 100	1070	3,5
5RE9102	CCr 112	1190	4,0
5RE9105	CCr 125	1320	4,5
5RE9110	CCr 140	1490	5,0
5RE9113	CCr 160	1690	6,0

Dimensioni in mm | Dimensions in mm

CCrc

Code	Tipo Type	ØA	B	Kg
5RE1581	CCrc 31	355	115	1
5RE1582	CCrc 35	395	115	1,1
5RE1583	CCrc 40	450	115	1,3
5RE1584	CCrc 45	500	115	1,5
5RE1585	CCrc 50	560	115	1,8
5RE1586	CCrc 56	620	115	2,2
5RE1587	CCrc 63	690	115	3
5RE1588	CCrc 71	770	150	4,5
5RE1589	CCrc 80	860	150	5,8
5RE1590	CCrc 90	970	305	7
5RE1591	CCrc 100	1070	305	8,5
5RE1592	CCrc 112	1190	305	10
5RE1593	CCrc 125	1320	305	11

1400/1600: su richiesta | upon request

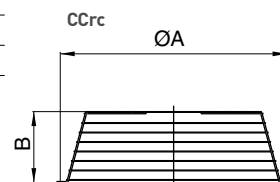
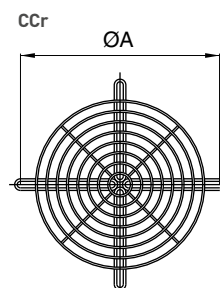

CCbo | BOCCAGLIO | INLET/OUTLET CONE

Permette un maggiore rendimento del ventilatore nel caso di bocche non canalizzate. Costruito in lamiera d'acciaio, con una flangia, realizzata a norma UNI ISO 6580 - EUROVENT, per il fissaggio al tamburo del CC e una bocca di aspirazione/diffusione ad ampio raggio con fori di fissaggio per rete CCr (di una taglia superiore, Es. CCbo 71 + CCr 80). Verniciato a polveri epossipoliestiriche.

It allows a higher fan efficiency in case of installation with inlet or outlet not ducted. Manufactured in steel sheet, with one flange according to UNI ISO 6580 - EUROVENT to be fitted to the CC fan, and an aerodynamically shaped bell mouth, with fixing holes for a protection guard (of one size bigger, example CCbo 71 + CCr 80). Protected against atmospheric agents by epoxy paint.

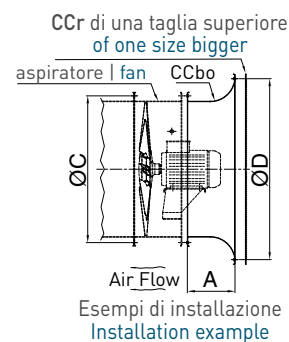
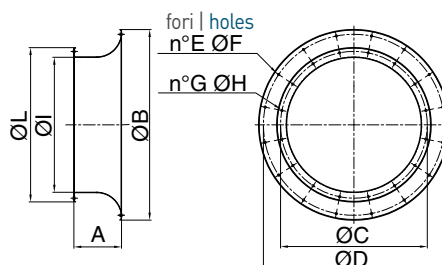

Code	Tipo Type	A	ØB	ØC	ØD	E	ØF	G	ØH	ØI	ØL	Kg
5B09631	CCbo 31	175	442	355	395	8	10	8	10	307	395	4,5
5B09635	CCbo 35	175	496	395	450	8	12	8	10	357	446	5
5B09640	CCbo 40	175	546	450	500	8	12	8	12	407	496	5,6
5B09645	CCbo 45	175	598	500	560	12	12	8	12	457	546	6,3
5B09650	CCbo 50	190	658	560	620	12	12	12	12	507	598	8,5
5B09656	CCbo 56	190	730	620	690	12	12	12	12	567	658	8,5
5B09663	CCbo 63	190	810	690	770	16	12	12	12	637	730	9,8
5B09671	CCbo 71	230	910	770	860	16	12	16	12	708	810	12,4
5B09680	CCbo 80	250	1025	860	970	16	16	16	12	808	910	15,2
5B09690	CCbo 90	300	1125	970	1070	16	16	16	16	910	1030	29,4
5B09700	CCbo 100	300	1245	1070	1190	20	16	16	16	1010	1130	33,3
5B09712	CCbo 112	300	1380	1190	1320	20	16	20	16	1130	1250	37,3
5B09725	CCbo 125	300	1525	1320	1470	20	16	20	16	1260	1380	42,5
5B09740	CCbo 140	300	1735	1470	1680	24	18	20	16	1415	1540	49,8
5B09760	CCbo 160	300	1935	1680	1880	24	18	24	18	1615	1750	57,2

Dimensioni in mm | Dimensions in mm

N.B.: Il flusso dell'aria potrebbe cambiare da girante a motore | Airflow direction could vary from impeller to motor.



CCsa | CCsb | SILENZIATORI CILINDRICI | CYLINDRICAL SILENCERS

I silenziatori cilindrici CCs sono disponibili in due versioni, senza ogiva (CCsa) e con ogiva (CCsb). La presenza dell'ogiva permette una maggiore attenuazione della rumorosità ma genera una perdita di carico aggiuntiva nell'impianto. Entrambe le versioni possono essere fissate alla flangia del CC corrispondente sia in aspirazione sia in mandata. La serie CCsa non genera perdite di carico aggiuntive. La serie CCsb, comporta una perdita di carico nella misura evidenziata nel diagramma di pagina 50. E' possibile fornire i silenziatori in versione di lunghezza pari a 1 - 1,5 - 2 volte il diametro (b). Questi silenziatori sono costruiti completamente in lamiera zincata, la parte interna e l'ogiva in lamiera forata al fine di permettere, efficacemente, l'azione del materasso fonoassorbente in lana minerale. La temperatura d'esercizio è compresa fra -40 e +150°C.

The cylindrical silencers CCs are available in two versions, without pod (CCsa) and with pod (CCsb). The presence of the pod allows a higher noise attenuation, but creates an additional pressure drop in the system. Both the versions can be fixed to the corresponding flange of the CC in inlet and outlet. The CCsa series doesn't create additional losses. The CCsb series gives an additional loss, as shown in the diagram at page 50.

Silencers can be provided with length equal to 1 - 1,5 - 2 times the diameter (b). These silencers are manufactured completely in galvanized steel. The internal part and the pod are made in perforated sheet, to effectively allow the sound absorption of the acoustic lining in mineral wool. The working temperature is included from -40°C and +150°C.

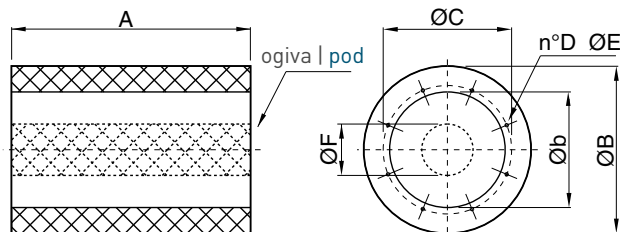

CCsa / CCsb

Tipo Type	ØB	Øb	ØC	D	ØE	ØF
31	455	315	355	8	M8	140
35	495	355	395	8	M8	200
40	540	400	450	8	M10	200
45	610	450	500	8	M10	245
50	660	500	560	12	M10	245
56	720	560	620	12	M10	295
63	790	630	690	12	M10	295
71	870	710	770	16	M10	380
80	1000	800	860	16	M10	380
90	1100	900	970	16	M12	380
100	1200	1000	1070	16	M12	650
112	1320	1120	1190	20	M12	650
125	1450	1250	1320	20	M12	650

CCsa

Tipo Type	A 1Ø	Kg	A 1,5Ø	Kg	A 2Ø	Kg
CCsa 31	315	8	472	11	630	14
CCsa 35	355	10	532	14	710	17
CCsa 40	400	12	600	17	800	21
CCsa 45	450	15	675	20	900	24
CCsa 50	500	18	750	25	1000	32
CCsa 56	560	21	840	28	1120	35
CCsa 63	630	24	945	33	1260	43
CCsa 71	710	35	1065	49	1420	63
CCsa 80	800	43	1200	61	1600	79
CCsa 90	900	70	1350	94	1800	112
CCsa 100	1000	113	1500	137	2000	161
CCsa 112	1120	130	1680	154	2240	178
CCsa 125	1250	152	1875	185	2500	213

CCsb

Tipo Type	A 1Ø	Kg	A 1,5Ø	Kg	A 2Ø	Kg
CCsb 31	315	10	472	14	630	16
CCsb 35	355	12	532	16	710	18
CCsb 40	400	14	600	21	800	26
CCsb 45	450	17	675	24	900	29
CCsb 50	500	23	750	32	1000	39
CCsb 56	560	28	840	37	1120	44
CCsb 63	630	32	945	44	1260	55
CCsb 71	710	44	1065	62	1420	78
CCsb 80	800	56	1200	79	1600	101
CCsb 90	900	130	1350	153	1800	175
CCsb 100	1000	143	1500	180	2000	216
CCsb 112	1120	165	1680	202	2240	238
CCsb 125	1250	193	1875	240	2500	282

Dimensioni in mm - Codici a richiesta
Dimensions in mm - Item code upon request

CCsb | DIAGRAMMA perdita di carico SILENZIATORI | SILENCER with pod loss charge DIAGRAM

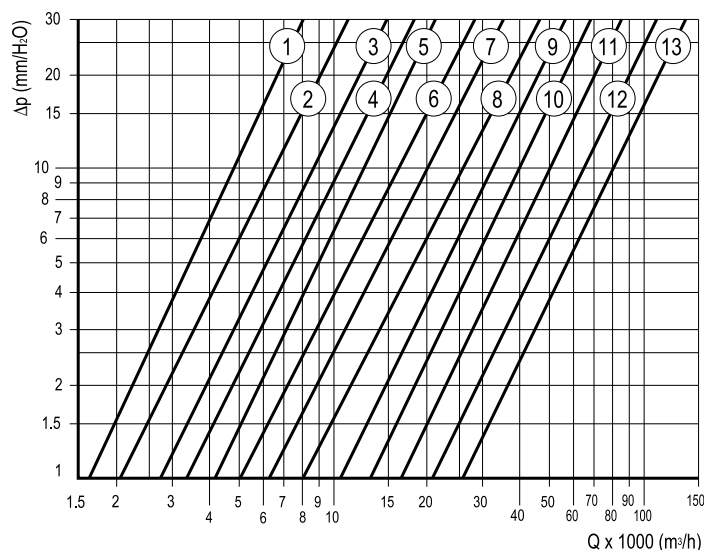

N.B.: Versioni senza ogiva (CCsa) hanno perdita di carico irrilevante.
Without pod (CCsa) loss charge irrelevant.

CCsb

Tipo Type	n°
CCsb 31	1
CCsb 35	2
CCsb 40	3
CCsb 45	4
CCsb 50	5
CCsb 56	6
CCsb 63	7
CCsb 71	8
CCsb 80	9
CCsb 90	10
CCsb 100	11
CCsb 112	12
CCsb 125	13



SILENZIATORI CILINDRICI Cylindrical silencers

CCsa silenzatori senza ogiva | without pod

Attenuazione in dB per banda di ottava (Hz)
Octave spectrum (Hz) of noise attenuation in dB

		A= 1 x Øb							
Tipo Type		63	125	250	500	1K	2K	4K	8K
31	1	1	3	8	14	9	8	7	
35	0	0	3	9	14	10	8	6	
40	0	0	4	10	13	8	8	5	
45	1	1	4	12	12	9	6	6	
50	0	0	4	13	11	9	6	5	
56	0	0	4	14	11	8	5	4	
63	1	1	5	14	10	9	5	5	
71	1	1	5	12	9	7	5	5	
80	2	3	7	9	8	6	5	4	
90	2	3	7	13	8	6	5	4	
100	2	3	8	12	8	4	4	4	
112	2	3	8	13	7	5	4	3	
125	2	3	9	13	7	4	4	3	

		A= 1,5 x Øb							
Tipo Type		63	125	250	500	1K	2K	4K	8K
31	1	2	5	12	19	13	11	8	
35	0	0	5	12	21	13	11	9	
40	1	1	5	14	19	12	10	8	
45	1	1	6	17	17	13	9	8	
50	1	1	6	18	17	12	9	7	
56	1	2	7	20	15	11	8	5	
63	1	2	7	20	14	12	8	6	
71	2	2	7	18	11	9	6	7	
80	2	5	10	13	12	9	7	7	
90	2	5	11	16	11	7	7	5	
100	2	5	12	17	10	6	6	5	
112	3	5	12	18	8	6	5	4	
125	3	6	12	17	8	5	5	4	

		A= 2 x Øb							
Tipo Type		63	125	250	500	1K	2K	4K	8K
31	4	6	6	16	26	17	13	9	
35	0	2	6	15	25	16	12	10	
40	0	2	7	18	24	15	12	9	
45	0	1	7	21	21	15	10	8	
50	1	2	8	23	21	14	11	8	
56	1	1	9	24	19	14	10	7	
63	1	2	9	25	17	14	10	7	
71	2	4	9	24	14	11	8	8	
80	4	6	13	22	14	10	9	7	
90	4	6	14	23	13	9	7	6	
100	4	6	16	23	12	7	7	6	
112	4	6	15	23	10	7	6	6	
125	5	8	17	22	10	6	6	5	

CCsb silenzatori con ogiva | with pod

Attenuazione in dB per banda di ottava (Hz)
Octave spectrum (Hz) of noise attenuation in dB

		A= 1 x Øb							
Tipo Type		63	125	250	500	1K	2K	4K	8K
31	0	1	4	9	16	17	13	10	
35	0	0	4	11	22	21	15	12	
40	0	1	4	11	20	18	14	11	
45	0	1	6	14	21	19	13	9	
50	1	2	5	13	20	16	11	8	
56	1	1	6	15	21	17	11	8	
63	1	1	6	15	19	16	10	8	
71	1	2	7	15	20	18	12	10	
80	2	3	9	12	17	15	9	8	
90	2	4	8	15	16	11	8	7	
100	4	8	14	20	24	21	14	10	
112	4	6	13	20	21	14	8	7	
125	4	7	12	18	19	10	6	6	

		A= 1,5 x Øb							
Tipo Type		63	125	250	500	1K	2K	4K	8K
31	2	4	5	13	23	26	18	12	
35	1	1	7	15	33	32	22	17	
40	1	2	6	15	31	27	19	14	
45	1	2	7	19	31	28	18	12	
50	2	3	7	19	29	24	14	10	
56	2	3	9	22	32	27	15	11	
63	2	2	9	22	29	23	14	10	
71	2	3	11	22	31	25	13	11	
80	3	6	13	18	26	22	12	11	
90	3	5	12	20	24	16	10	9	
100	6	10	22	30	37	29	16	12	
112	6	10	19	29	33	20	11	10	
125	6	10	18	26	29	14	9	7	

		A= 2 x Øb							
Tipo Type		63	125	250	500	1K	2K	4K	8K
31	3	6	7	17	32	33	22	17	
35	1	2	8	19	40	39	27	20	
40	1	2	9	20	37	35	23	16	
45	2	3	10	23	39	36	21	15	
50	2	3	10	24	38	32	18	12	
56	1	2	12	27	41	35	18	12	
63	2	3	11	27	37	29	15	12	
71	3	5	14	29	41	32	18	15	
80	3	6	16	29	35	26	15	12	
90	4	7	17	30	34	20	12	11	
100	7	13	28	39	47	38	19	13	
112	8	14	26	36	42	24	13	11	
125	7	13	25	35	37	17	11	9	



CCpro | PROLUNGA | LONG CASING EXTENSION

Permette la realizzazione, anche in sito, della versione a cassa lunga con girante e motore completamente protetti dalla cassa del ventilatore. Costruita in lamiera d'acciaio, con flange di fissaggio realizzate a norma UNI ISO 6580 - EUROVENT. Verniciata a polveri epossipoliestiriche. Completa di portellina d'ispezione e fori per passaggio cavi.

Turns the standard short case execution into a long case version, also at site, with impeller and motor completely protected inside the casing. Manufactured in steel sheet, with fixing flanges according to UNI ISO6580 - EUROVENT standard. Protected against atmospheric agents by epoxy-paint. Complete of inspection porthole and holes for cable.

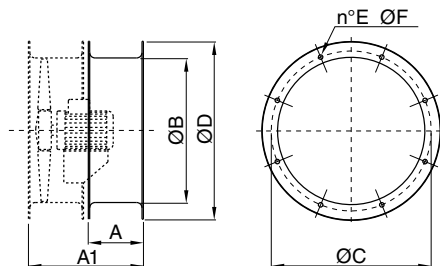

Code	Tipo Type	A	A1	ØB	ØC	ØD	E	ØF	Kg
1CC9313	CCpro 31	180	380	305	355	395	8	10	4
1CC9351	CCpro 35	180	380	355	395	446	8	10	5
1CC9402	CCpro 40	200	430	400	450	496	8	12	6
1CC9451	CCpro 45	200	430	450	500	546	8	12	7
1CC9502	CCpro 50	200	450	500	560	598	12	12	8
1CC9561	CCpro 56	200	450	560	620	658	12	12	9
1CC9632	CCpro 63	240	490	630	690	730	12	12	11
1CC9712	CCpro 71	280	530	710	770	810	16	12	13
1CC9802	CCpro 80	240	590	800	860	910	16	12	20
1CC9901	CCpro 90	340	690	900	970	1030	16	16	31
1CC9912	CCpro 100	410	760	1000	1070	1130	16	16	39
1CC9921	CCpro 112	410	760	1120	1190	1250	20	16	58
1CC9927	CCpro 125	410	760	1250	1320	1380	20	16	65
1CC9930	CCpro 140	510	960	1415	1470	1540	20	16	88
1CC9931	CCpro 160	510	960	1615	1680	1730	24	18	98

I codici riportati sono quelli della prolunga montata.
The reported item codes are relative to the assembled extension.

CCga | GIUNTO ANTIVIBBRANTE | FLEXIBLE CONNECTORS

Impedisce la propagazione delle vibrazioni sulla canalizzazione. Costruito con due flange in lamiera d'acciaio, realizzate a norma UNI ISO 6580 - EUROVENT per il fissaggio al ventilatore e al canale, ed un nastro di collegamento flessibile e robusto. Temperature d'utilizzo -30°C +80°C. Parti in lamiera verniciate a polveri epossipoliestiriche. Per temperature d'utilizzo diverse sono previste costruzioni speciali.

It prevents the propagation of vibrations along the ducted system. Manufactured with two flanges in steel sheet, according to UNI ISO6580 - EUROVENT standard for fixing to the fan and to the duct, and a strong flexible fabric joint. Working temperatures from -30°C to +80°C. Components in steel sheet protected against atmospheric agents by epoxy paint. Special executions are available for different working temperatures.

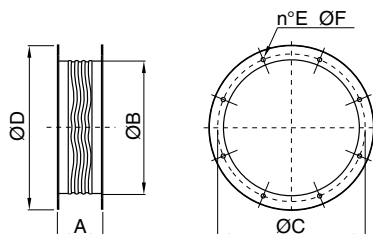

Code	Tipo Type	A	ØB	ØC	ØD	E	ØF	Kg
1SU5310	CCga 31	200	305	355	395	8	10	5
1SU5350	CCga 35	200	355	395	446	8	10	6
1SU5400	CCga 40	200	405	450	496	8	12	7
1SU5450	CCga 45	200	455	500	546	8	12	8
1SU5500	CCga 50	200	505	560	598	12	12	9
1SU5560	CCga 56	200	565	620	658	12	12	10
1SU5630	CCga 63	200	635	690	730	12	12	11
1SU5710	CCga 71	200	708	770	810	16	12	13
1SU5800	CCga 80	200	808	860	910	16	12	21
1SU5900	CCga 90	200	908	970	1030	16	16	23
1SU6000	CCga 100	200	1010	1070	1130	16	16	26
1SU6120	CCga 112	200	1130	1190	1250	20	16	29
1SU6125	CCga 125	200	1260	1320	1380	20	16	32

Dimensioni in mm | Dimensions in mm
1400/1600: su richiesta | upon request

CCst | STAFFE DI SOSTEGNO | SUPPORT FEET

Consentono l'ancoraggio del ventilatore a pavimento o soffitto. Realizzate in lamiera d'acciaio e verniciate a polveri epossipoliestiriche. Fornite a coppia.

Suitable to fasten the fan on the floor or to the ceiling. Manufactured in steel sheet and protected against atmospheric agents by epoxy paint. Supplied in sets of 2.

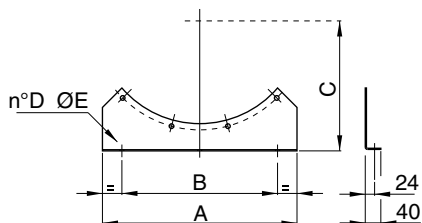

Code*	Tipo Type	A	B	C	D	ØE	Kg**
1ST0310	CCst 31	320	200	280	2	10	1,1
1ST0350	CCst 35	350	250	300	2	10	1,25
1ST0400	CCst 40	400	300	320	2	10	1,3
1ST0450	CCst 45	450	350	350	2	10	1,5
1ST0500	CCst 50	500	400	380	2	10	2,1
1ST0560	CCst 56	560	460	410	2	10	2,5
1ST0630	CCst 63	630	480	450	2	10	2,8
1ST0710	CCst 71	710	550	490	2	10	3,1
1ST0800	CCst 80	800	660	540	3	14	3,7
1ST0900	CCst 90	900	760	600	3	14	4,5
1ST1000	CCst 100	1000	860	640	3	14	4,8
1ST1120	CCst 112	1120	980	710	3	14	6,8
1ST1250	CCst 125	1250	950	770	3	14	7,8
1ST1400	CCst 140	1400	1100	850	3	14	18
1ST1600	CCst 160	1600	1300	960	3	16	28,5

Dimensioni in mm - * Codice della coppia - ** Peso di una staffa
Dimensions in mm - *Item code of the set of 2 - **Weight of a single support



CCf | CONTROFLANGIA | COUNTER FLANGE

Piastra a forma di anello provvista di fori a norma UNI ISO 6580 – EUROVENT. Viene utilizzata per facilitare il collegamento tra il canale ed il ventilatore.

Ring plate with holes according to UNI ISO6580 – EUROVENT standard, compatible with fan flange. It is used for easier connection between the CC fan and the duct.

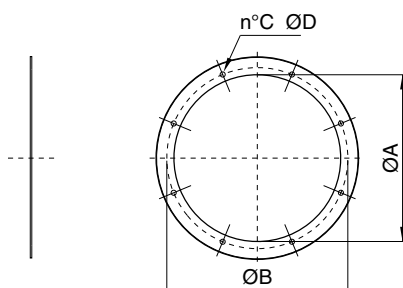

Code	Tipo Type	ØA	ØB	C	ØD	Kg
5B01031	CCf 31	315	355	8	10	1,2
5B01035	CCf 35	350	395	8	10	1,5
5B01040	CCf 40	400	450	8	12	1,7
5B01045	CCf 45	450	500	8	12	1,9
5B01050	CCf 50	500	560	12	12	2,1
5B01056	CCf 56	560	620	12	12	2,4
5B01063	CCf 63	630	690	12	12	2,7
5B01071	CCf 71	710	770	16	12	3,3
5B01081	CCf 80	800	860	16	12	3,7
5B01092	CCf 90	900	970	16	16	4,7
5B01110	CCf 100	1000	1070	16	16	5,2
5B01212	CCf 112	1120	1190	20	16	6,5
5B01210	CCf 125	1250	1320	20	16	8
-	CCf 140	1415	1470	20	16	10
-	CCf 160	1615	1680	24	18	12

Dimensioni in mm - 1400/1600: codice a richiesta
Dimensions in mm - item codes upon request

CCfc | GIUNTO ANTIVIBRANTE | FLEXIBLE CONNECTORS

Controflangia a forma di anello con collare, provvista di fori a norma UNI ISO 6580 – EUROVENT. Viene utilizzata per facilitare il collegamento tra il canale ed il ventilatore.

Counter flange with addition of 80 mm of round duct. It is used for easier connection between the CC fan and the duct.

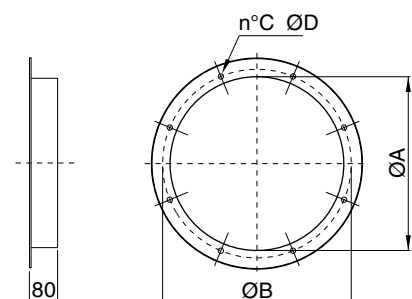

Code	Tipo Type	ØA	ØB	C	ØD	Kg
5B01531	CCfc 31	305	355	8	10	1,3
5B01535	CCfc 35	355	395	8	10	1,5
5B01540	CCfc 40	405	450	8	12	1,7
5B01545	CCfc 45	455	500	8	12	2
5B01550	CCfc 50	505	560	12	12	2,2
5B01556	CCfc 56	565	620	12	12	2,5
5B01563	CCfc 63	635	690	12	12	2,9
5B01571	CCfc 71	710	770	16	12	3,3
5B01580	CCfc 80	808	860	16	12	3,8
5B01590	CCfc 90	908	970	16	16	4,2
5B01600	CCfc 100	1010	1070	16	16	5
5B01620	CCfc 112	1130	1190	20	16	5,8
5B01625	CCfc 125	1260	1320	20	16	6,5

Dimensioni in mm | Dimensions in mm
1400/1600: su richiesta | upon request

CCot | TERMINALE CON RETE | OUTLET TERMINAL

Terminale parapoggia con rete di protezione.
Outlet raincover terminal with protection guard.

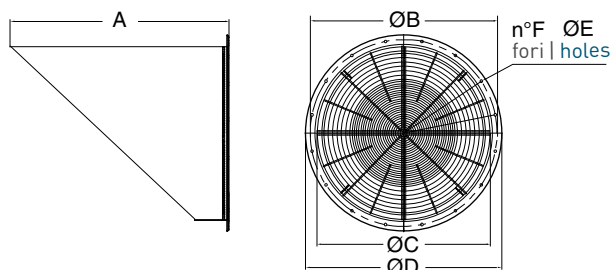

Code	Tipo Type	A	ØB	ØC	ØD	F	ØE	Kg
5TR0500	CCot 40	550	450	400	503	12	8	10
5TR0501	CCot 45	600	500	450	553	12	8	11
5TR0502	CCot 50	655	560	500	603	12	12	12,5
5TR0503	CCot 56	710	620	560	663	12	12	15
5TR0504	CCot 63	785	690	630	733	12	12	18
5TR0505	CCot 71	865	770	710	813	12	16	22
5TR0506	CCot 80	950	860	800	903	12	16	39
5TR0507	CCot 90	1050	970	900	1013	16	16	48
5TR0508	CCot 100	1200	1070	1000	1113	16	16	80
5TR0509	CCot 112	1325	1190	1120	1233	16	20	97
5TR0510	CCot 125	1455	1320	1250	1367	16	20	118
5TR0511	CCot 140	1605	1470	1415	1530	16	20	144
5TR0512	CCot 160	1805	1680	1615	1730	16	24	182

Dimensioni in mm | Dimensions in mm