



# DZD Ex t

## Torrino assiale, scarico orizzontale Axial roof fan, horizontal air outlet



Ex II 2D Ex tb IIIB T135°C/T200°C Db IP64 X /  
Ex II 2D Ex h IIIB T135°C/T200°C Db X  
DUST

### NORME | NORMS

IEC 60079-0  
IEC 60079-31  
IEC 60079-7  
ISO 80079-36  
ISO 80079-37  
EN ISO 80079-36  
EN ISO 80079-37

### Attestato di Esame del Tipo Type Examination Statement



TÜV-A 19 ATEX0104 X, IECEx EPS 19.0020X

### A RICHIESTA UPON REQUEST

- Versioni a 60 Hz
- Versions at 60 Hz

### VERSIONI | VERSIONS



DZD Ex e

Ex II 2G Ex eb IIB+H2 T3/T4 Gb X /  
Ex II 2G Ex h IIB+H2 T3/T4 Gb X  
GAS/HYDROGEN

#### DESCRIZIONE

Progettati per essere utilizzati in zona 21 e 22, ossia in aree o ambienti dove sia necessario garantire un elevato fattore di sicurezza contro le esplosioni dovute alla presenza di polveri combustibili (II2D), in conformità alla Direttiva Europea 2014/34/UE e allo schema IECEx.

Indicati per tutte le polveri del gruppo Ex IIIA e IIIB.

Temperature di utilizzo da -20°C a +40°C (25/2, 30/6, 35/6, 40) / +60°C (25/4, 30/4, 30/2, 35/4, 35/2, 50/4, 60/6).

#### CONSTRUZIONE

- Girante assiale in plastica conduttiva.
- Grado di equilibratura G 6.3 secondo la categoria BV-3 in conformità alla norma ISO 14694.
- Base di fissaggio, bocchetta di aspirazione e copertura anti pioggia in lamiera d'acciaio zincata.

#### MOTORE

Robusto motore asincrono trifase reversibile dotato di cuscinetti a sfera, esente da manutenzione. Reversibilità: la portata volumetrica si riduce di circa il 35% in caso di direzione invertita del flusso d'aria.

Modalità di funzionamento S1 (servizio continuo). Regolabile tramite regolatori della serie TR (ad eccezione del DZD 35/2 B Ex).

Motore dotato di sistemi di protezione da sovratemperatura con termistori tipo PTC.

Sistema di protezione consigliato: PTC MAICO MVS 6 o TMS. Grado di protezione IP 64. Protezione contro l'accensione: sicurezza aumentata di tipo "e" e sicurezza costruttiva di tipo "c".

#### ACCESSORI

- SD - Silenziatori
- ELA Ex - Giunto flessibile
- SG - Griglia di protezione
- SO - Base per tetti piani
- SZ - Raccordo intermedio
- DDEx - Pressostato differenziale
- DSS - Regolatore 5 V
- MVS6 - Quadro controllo termistore PTC
- TMS - Relè di protezione termistore
- TR - Trasformatori
- SOWT - Tronchetto per tetti ondulati e trapezoidali
- SDS - Zoccolo per tetti inclinati

#### DESCRIPTION

Designed to fulfil the safety requirements of European Directive 2014/34/EU for units and protective systems in potentially explosive atmospheres in zone 21 and 22. Explosion protection and approvals in accordance with ATEX and IECEx scheme.

Qualified for all dusts of the Ex-group IIIA and IIIB.

For usage temperatures from -20°C to +40°C (25/2, 30/6, 35/6, 40) / +60°C (25/4, 30/4, 30/2, 35/4, 35/2, 50/4, 60/6).

#### CONSTRUCTION

- Axial impeller made of conductive plastic.
- Balance quality of the motor/impeller combination G 6.3 according to category BV-3 in accordance with ISO 14694.
- Base plate, intake nozzle and rain protection cover made of galvanised sheet steel.

#### MOTOR

Robust reversible three-phase AC motor with ball bearings, maintenance-free.

Reversing mode: the volumetric flow is reduced by approx. 35% with reverse air flow direction.

S1 operating mode (continuous operation). Speed control permitted with TR transformer (exception: DZD 35/2 B Ex).

The temperature in the fan motor is monitored by PTC thermistors.

The MAICO PTC thermistor triggering device MVS 6 or TMS is recommended. IP 64 degree of protection. Types of ignition protection: "e"-increased safety and "c"-constructional safety.

#### ACCESSORIES

- SD - Silencers
- ELA Ex - Flexible coupling
- SG - Safety grille
- SO - Roof socket for flat roofs
- SZ - Intermediate socket
- DDEx - Differential pressure switch
- DSS - 5-speed controller
- MVS6 - PTC thermistor triggering device
- TMS - Thermistor overload relay
- TR - Transformers.
- SOWT - Roof socket for corrugated and trapezoidal roofs
- SDS - Roof socket for pitched roofs

### DZD Ext 250

Code	Tipo Type	Modello Model	U	P	Pm (kW)	In (A)	IP/CL	Q max m <sup>3</sup> /h	LwA5 dB(A)*
1DZ2525	DZD	25/4 B Ext	T	4	0,038	0,19	64/F	800	68
1DZ2526		25/2 B Ext	T	2	0,14	0,39	64/F	1.600	87

\*Livello di potenza sonora in dB a bocca libera  
Free inlet sound power level in dB

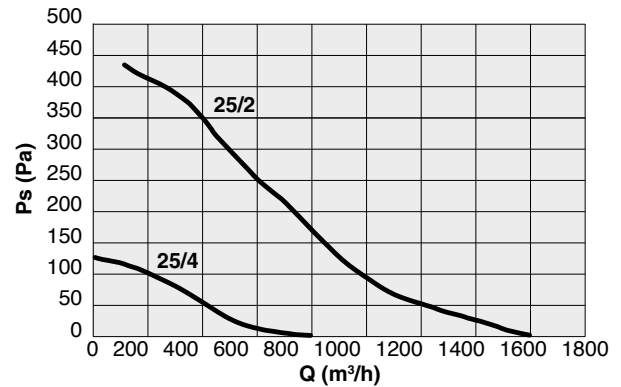

### DZD Ext 300

Code	Tipo Type	Modello Model	U	P	Pm (kW)	In (A)	IP/CL	Q max m <sup>3</sup> /h	LwA5 dB(A)*
1DZ3045	DZD	30/6 B Ext	T	6	0,025	0,12	64/F	940	64
1DZ3046		30/4 B Ext	T	4	0,095	0,48	64/F	1.390	74
1DZ3047		30/2 B Ext	T	2	0,3	0,87	64/F	2.690	91

\*Livello di potenza sonora in dB a bocca libera  
Free inlet sound power level in dB

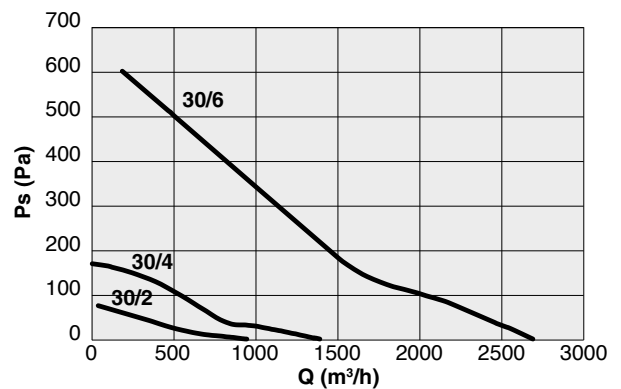

### DZD Ext 350

Code	Tipo Type	Modello Model	U	P	Pm (kW)	In (A)	IP/CL	Q max m <sup>3</sup> /h	LwA5 dB(A)*
1DZ3548	DZD	35/6 B Ext	T	6	0,04	0,13	64/F	1.370	69
1DZ3549		35/4 B Ext	T	4	0,13	0,49	64/F	2.060	77
1DZ3550		35/2 B Ext	T	2	0,62	1,91	64/F	4.280	97

\*Livello di potenza sonora in dB a bocca libera  
Free inlet sound power level in dB

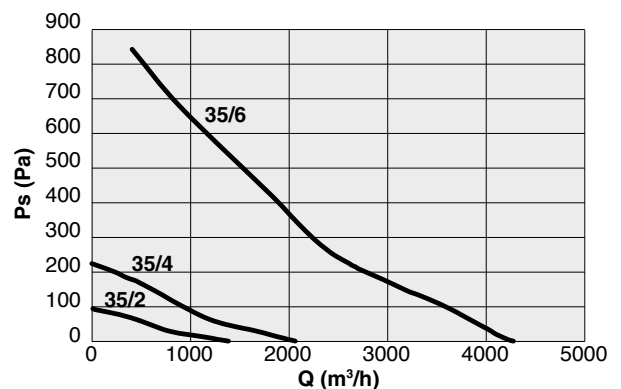

## DZD Ext 400

Code	Tipo Type	Modello Model	U	P	Pm (kW)	In (A)	IP/CL	Q max m <sup>3</sup> /h	LwA5 dB(A)*
1DZ4050	DZD	40/6 B Ext	T	6	0,1	0,53	64/F	2.130	74
1DZ4051		40/4 B Ext	T	4	0,17	0,70	64/F	3.200	84

\*Livello di potenza sonora in dB a bocca libera  
Free inlet sound power level in dB

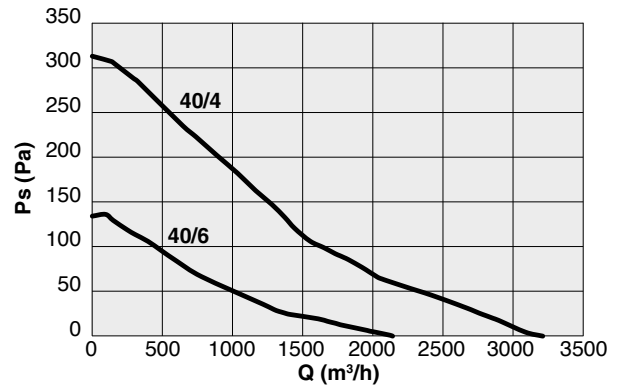

## DZD Ext 500

Code	Tipo Type	Modello Model	U	P	Pm (kW)	In (A)	IP/CL	Q max m <sup>3</sup> /h	LwA5 dB(A)*
1DZ5044	DZD	50/6 B Ext	T	6	0,18	0,65	64/F	3.870	77
1DZ5045		50/4 B Ext	T	4	0,485	1,70	64/F	5.830	88

\*Livello di potenza sonora in dB a bocca libera  
Free inlet sound power level in dB

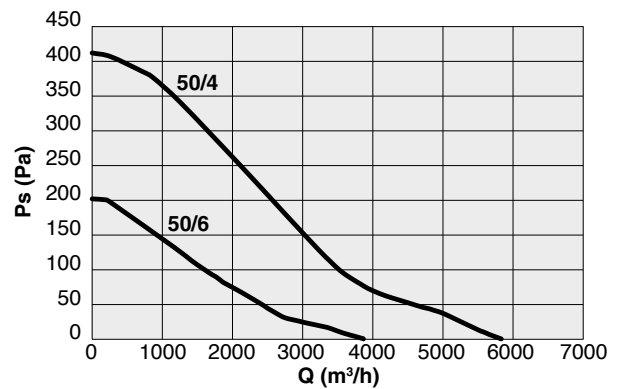

## DZD Ext 600

Code	Tipo Type	Modello Model	U	P	Pm (kW)	In (A)	IP/CL	Q max m <sup>3</sup> /h	LwA5 dB(A)*
1DZ6063	DZD	60/6 B Ext	T	6	0,365	1,08	64/F	6.510	83

\*Livello di potenza sonora in dB a bocca libera  
Free inlet sound power level in dB

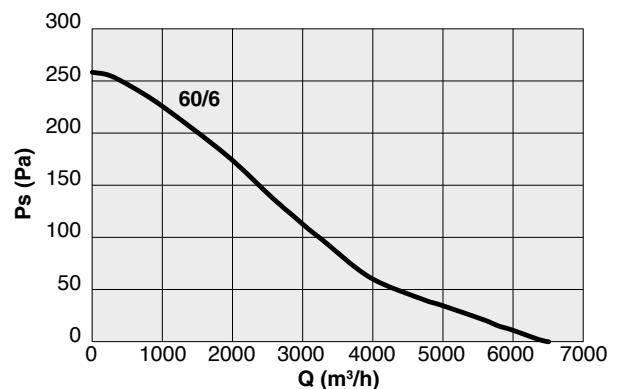

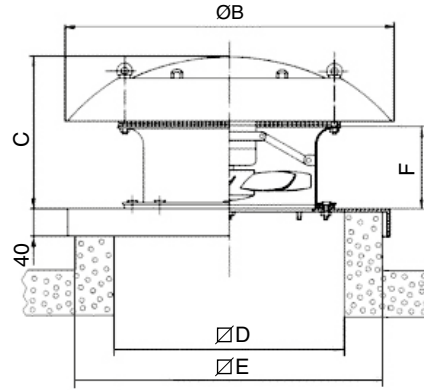
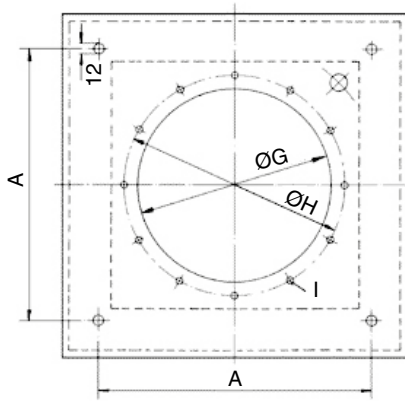

## DZD Ext

TIPO   TYPE	A	ØB	C	ØD	ØE	F	ØG	ØH	I	Kg
DZD Ext 250	500	570	285	355	560	170	263	286	7	14
DZD Ext 300	570	660	335	405	630	190	313	356	9	20
DZD Ext 355	610	720	340	455	670	190	363	395	9	24
DZD Ext 400	650	830	375	505	710	190	413	438	9	27
DZD Ext 500	800	940	380	605	860	190	513	541	9	39
DZD Ext 600	840	1.100	420	720	900	190	613	674	11	43

Pesi indicativi | Indicative weights



## SD | SILENZIATORI | SILENCERS

Silenziatore per l'isolamento acustico del lato aspirante dei ventilatori da tetto.

Con elementi silenziatori in lastre di fibra minerale resistenti all'abrasione e non infiammabili.

Silencer for suction side sound insulation of roof fans.

With silencing elements made of abrasion-resistant and non-flammable mineral fibre plates.

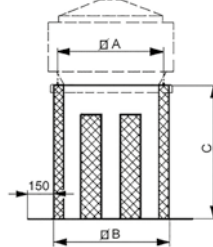

Code	Tipo   Type	∅A	∅B	∅C
5SD2501	SD 25	500	545	850
5SD2502	SD 31	570	615	850
5SD2503	SD 35	610	655	850
5SD2504	SD 40	650	695	850
5SD2505	SD 50	800	855	850

Dimensioni in mm | Dimensions in mm

## ELA Ex | GIUNTO FLESSIBILE | FLEXIBLE COUPLING

Giunto flessibile per il collegamento smorzato di condotti di ventilazione. Adatto per l'uso in aree soggette a rischio di esplosione.

Flexible coupling for the sound and vibration damped connection of ventilation ducts.

Suitable for use in areas subject to explosion hazards.

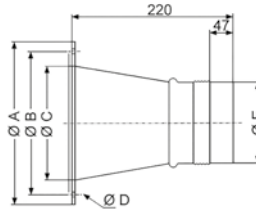

Code	Tipo   Type	∅A	∅B	∅C	∅D	∅E
5EL0001	ELA 25 Ex	304	286	262	7	247
5EL0002	ELA 30 Ex	380	356	312	9,5	297
5EL0003	ELA 35 Ex	420	395	362	9,5	347
5EL0004	ELA 40 Ex	460	438	412	9,5	397
5EL0006	ELA 50 Ex	565	541	512	9,5	497
5EL0007	ELA 60 Ex	710	674	612	14	597

Dimensioni in mm | Dimensions in mm

## SG | GRIGLIA DI PROTEZIONE | SAFETY GRILLE

Griglia di protezione in metallo.

Safety grille in metal.

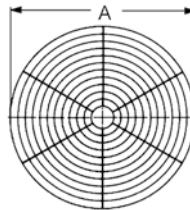

Code	Tipo   Type	∅A
5RE2135	SG 25	297
5RE2136	SG 30	369
5RE2137	SG 35	410
5RE2138	SG 40	455
5RE2140	SG 50	558
5RE2142	SG 60	698

Dimensioni in mm | Dimensions in mm

## SO | BASE PER TETTI PIANI | ROOF SOCKET FOR FLAT ROOFS

Base per tetto piatto per il montaggio di ventilatori da tetto.

Con isolamento acustico e termico non infiammabile.

Flat roof socket for assembly of roof fans.

With non-flammable sound and heat insulation.

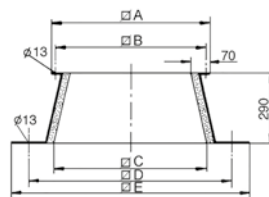
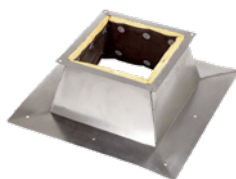

Code	Tipo   Type	∅A	∅B	∅C	∅D	∅E
5S02501	SO 25	540	500	540	750	900
5S02502	SO 30	610	570	610	820	970
5S02503	SO 35	650	610	650	860	1.010
5S02504	SO 40	690	650	690	900	1.050
5S02505	SO 50	840	800	840	1.050	1.200
5S02506	SO 60	880	840	880	1.090	1.240

Dimensioni in mm | Dimensions in mm



## SZ | RACCORDO INTERMEDIO | INTERMEDIATE SOCKET

Raccordo intermedio per ventilatori da tetto.

Per un collegamento tra il silenziatore SD e i condotti di ventilazione, economico in termini di flusso d'aria e facile da montare. Per l'installazione su tetti piani.

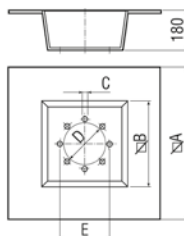

Intermediate sockets for roof fans.

For a connection between the SD socket sound absorber and the ventilation ducts that is economical in terms of air flow and easy to mount.

For installation in flat roofs.

Code	Tipo   Type	Modello   Model	ØA	ØB	C	D	E
5SZ0001	SZ 25	DZD 25/4 B Ex e	840	440	7	262	286
5SZ0002	SZ 31	DZD 30/6 B Ex e	910	510	9,5	312	356
5SZ0003	SZ 35	DZD 35/6 B Ex e	950	550	9,5	362	395

Dimensioni in mm | Dimensions in mm

## DDEx | PRESSOSTATO DIFFERENZIALE | DIFFERENTIAL PRESSURE SWITCH

Pressostato differenziale per la determinazione della differenza di pressione tra due valori di pressione compresi tra 0 - 500 Pa.

Il pressostato può essere parametrizzato in loco, utilizzando il menu di navigazione, senza ulteriori ausili elettronici.

Il punto di commutazione è liberamente scalabile nell'intervallo di impostazione 25 - 500 Pa.

Differential pressure switch for determining the pressure difference between two pressure values between 0 - 500 Pa.

The pressure switch can be parameterised on site, using the menu navigation, without additional electronic aids.

The switching point is freely scalable within the setting range 25 - 500.



Code	Misure   Size
5DD0000	107 x 180 x 66

Dimensioni in mm | Dimensions in mm

## DSS | REGOLATORE 5 VELOCITÀ AD AUTOTRASFORMATORE 5-STEP SWITCH SPEED TRANSFORMER

Adatto per motori AC.  
Corrente max. 20 A.

Suited for AC fans.  
Max load 20 A.



Code	Tipo   Type	IP
5TR2006	DSS Vedi tabella abbinamento See Pairing table	00

## MVS6 | QUADRO CONTROLLO TERMISTORE PTC | PTC THERMISTOR TRIGGERING DEVICE

Sistema completo indipendente.  
Dispositivo di attivazione del termistore PTC per il monitoraggio della temperatura massima del motore.  
Testato secondo la direttiva 2014/34/UE.  
Con spia di funzionamento.  
Installazione esclusivamente in aree non esplosive.

Independent complete system.  
PTC thermistor triggering device for monitoring the maximum motor temperature.

Type-examination tested according to Directive 2014/34/EU.

With operating indicator light  
Installation exclusively in non-explosive areas.

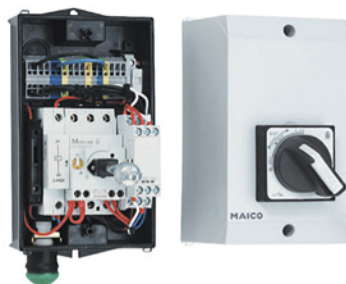

Code	Tipo   Type	Modello   Model	IP
5MV0004	MVS 6	DZQ 20/60	65



## TMS | RELE DI PROTEZIONE TERMISTORE | THERMISTOR OVERLOAD RELAY

Termistore del relè di protezione della macchina.  
Installazione esclusivamente in aree non esplosive.

Machine protection relay thermistor.  
Installation exclusively in non-explosive areas.



Code	Tipo   Type	Modello   Model	IP
5MV0003	TMS	DZD 20/60	20

## TR | TRASFORMATORI | TRANSFORMERS

TR 0,4-2  
TR 0,8-2  
TR 2,5-2



Tipo di installazione: montaggio in superficie  
Type of installation: surface-mounted

TR 0,8 S-2  
TR 2,5 S-2



Tipo di installazione: armadio di comando. NB: fornito a coppia  
Type of installation: control cabinet. NB: packing unit 2pcs

Code	Tipo Type	Trifase Three-phase	Tensione nominale Rated voltage	Frequenza Frequency	Potenza nominale Nominal output	Carico massimo Maximum load	Grado di protezione Degree of protection	Tensione secondaria Secondary voltage	Peso Weight	Dimensioni Dimension
			V	Hz	W	A	IP	V	Kg	mm
5TR2004	TR 0,4-2	AC	400	50 / 60	200	0,4	54	105 / 150 / 190 / 250 / 400	3,3	248 x 205 x h195
5TR2005	TR 0,8 S-2	AC	400	50 / 60	144	0,8	00	105 / 150 / 190 / 250 / 400	3,9	84 x 75 x h95
5TR2007	TR 0,8-2	AC	400	50 / 60	400	0,8	54	105 / 150 / 190 / 250 / 400	5	248 x 205 x h195
5TR2008	TR 2,5-2	AC	400	50 / 60	1.250	2,5	54	105 / 150 / 190 / 250 / 400	10	228 x 225 x h310
5TR2009	TR 2,5 S-2	AC	400	50 / 60	450	2,5	00	105 / 150 / 190 / 250 / 400	8	120 x 120 x h90

Dimensioni in mm | Dimensions in mm

## TABELLA ABBINAMENTO | PAIRING TABLE

Tipo   Type	Code	DDEx	DSS 20	MVS 6	TMS	TR 0,4-2	TR 0,8-2	TR 0,8 S-2	TR 2,5-2	TR 2,5 S-2
	e / t	5DD0000	5TR2006	5MV0004	5MV0003	5TR2004	5TR2007	5TR2005	5TR2008	5TR2009
DZD 25/2 B Ex e/t	1DZ2524 / 1DZ2526	✓	✓	✓	✓	✓		✓		
DZD 25/4 B Ex e/t	1DZ2521 / 1DZ2525	✓	✓	✓	✓	✓		✓		
DZD 30/2 B Ex e/t	1DZ3028 / 1DZ3047	✓	✓	✓	✓				✓	✓
DZD 30/4 B Ex e/t	1DZ3027 / 1DZ3046	✓	✓	✓	✓		✓	✓		
DZD 30/6 B Ex e/t	1DZ3026 / 1DZ3045	✓	✓	✓	✓		✓	✓		
DZD 35/2 B Ex e/t	1DZ3544 / 1DZ3550	✓		✓	✓					
DZD 35/4 B Ex e/t	1DZ3543 / 1DZ3549	✓	✓	✓	✓		✓	✓		
DZD 35/6 B Ex e/t	1DZ3542 / 1DZ3548	✓	✓	✓	✓		✓	✓		
DZD 40/4 B Ex e/t	1DZ4544 / 1DZ4051	✓	✓	✓	✓		✓	✓		
DZD 40/6 B Ex e/t	1DZ4543 / 1DZ4050	✓	✓	✓	✓		✓	✓		
DZD 50/4 B Ex e/t	1DZ5062 / 1DZ5045	✓	✓	✓	✓				✓	✓
DZD 50/6 B Ex e/t	1DZ5061 / 1DZ5044	✓	✓	✓	✓		✓	✓		
DZD 60/6 B Ex e/t	1DZ6063 / 1DZ6063	✓	✓	✓	✓				✓	✓



## SOWT | TRONCHETTO PER TETTI ONDULATI E TRAPEZOIDALI ROOF SOCKET FOR CORRUGATED AND TRAPEZOIDAL ROOFS

Con isolamento acustico e termico in lastre di fibra minerale resistenti all'abrasione e non infiammabili. Modelli standard per tetti con inclinazione fino a 30°. Su richiesta è possibile variare l'altezza dei tronchetti e i modelli per tetti con inclinazione superiore a 30°.

With sound and heat insulation made of abrasion-resistant and non-flammable mineral fibre plates. Standard models for up to 30° roof pitch. Varying socket heights and models for roof pitches of more than 30° are possible on request.

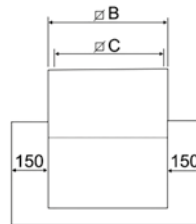
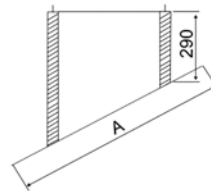

Code	Tipo   Type	A	ØB	ØC
5S02507	SOWT 25	845	545	500
5S02508	SOWT 31	915	615	570
5S02509	SOWT 35	955	655	610
5S02510	SOWT 40	955	695	650
5S02511	SOWT 45	1095	785	740
5S02512	SOWT 50	1.145	845	800

Dimensioni in mm | Dimensions in mm

## SDS | ZOCCOLO PER TETTI INCLINATI | ROOF SOCKET FOR PITCHED ROOFS

Preso per tetto piatto per il montaggio di ventilatori da tetto su tetti in tegole, modelli standard per tetti con inclinazione fino a 30°.

Flat roof socket for assembly of roof fans on tiled roofs, standard models for up to 30° roof pitch.

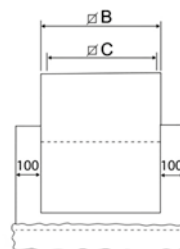
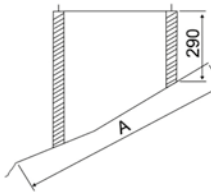

Code	Tipo   Type	A	ØB	ØC
5SD0001	SDS 25	845	545	500
5SD0002	SDS 31	915	615	570
5SD0003	SDS 35	955	655	610
5SD0004	SDS 40	955	695	650
5SD0005	SDS 45	1095	785	740
5SD0006	SDS 50	1.145	845	800

Dimensioni in mm | Dimensions in mm