



DZQ Ex t

Aspiratore assiale a telaio quadro Axial fan with square wall plate



Ex II 2D Ex tb III B T135°C/T200°C Db IP64 X /
Ex II 2D Ex h III B T135°C/T200°C Db X
DUST

NORME | NORMS

EN 14986:2017
EN 1127-1
EN ISO 80079-36
EN ISO 80079-37

Attestato di Esame del Tipo
Type Examination Statement



TÜV-A 19 ATEX0102 X, IECEx EPS 19.0018X

A RICHIESTA UPON REQUEST

- Versioni a 60 Hz
- Versioni a telaio tondo (DZS/EZS)
- Versioni monofase a telaio quadro (EZQ)
- Versions at 60 Hz
- Round frame versions (DZS/EZS)
- Single-phase square frame versions (EZQ)

VERSIONI | VERSIONS



DZQ Ex e

Ex II 2G Ex eb IIB+H2 T3/T4 Gb X /
Ex II 2G Ex h IIB+H2 T3/T4 Gb X
GAS/HYDROGEN

DESCRIZIONE

Progettati per essere utilizzati in zona 21 e 22, ossia in aree o ambienti dove sia necessario garantire un elevato fattore di sicurezza contro le esplosioni dovute alla presenza di polveri combustibili (II2D), in conformità alla Direttiva Europea 2014/34/UE e allo schema IECEx.

Temperature di utilizzo da -20°C a +60°C. Può essere commutato su ventilazione o estrazione dell'aria.

Indicati per tutte le polveri del gruppo Ex IIIA e IIIB.

COSTRUZIONE

- Girante assiale in plastica conduttiva.
- Grado di equilibratura G 6.3 secondo la categoria BV-3 in conformità alla norma ISO 14694.
- Griglia di protezione sul lato di aspirazione, protezione contro il contatto accidentale in conformità alla norma DIN EN ISO 13857.
- Può essere montata in qualsiasi posizione.

MOTORE

- Robusto motore asincrono trifase reversibile dotato di cuscinetti a sfera, esente da manutenzione.
- Reversibilità: la portata volumetrica si riduce di circa il 35% in caso di direzione invertita del flusso d'aria.
- Modalità di funzionamento S1 (servizio continuo).
- Regolabile tramite regolatori della serie TR (ad eccezione del DZQ 35/2 B Ex).
- Motore dotato di sistemi di protezione da sovratemperature con termistori tipo PTC.
- Sistema di protezione consigliato: PTC MAICO MVS 6 o TMS.
- Grado di protezione IP 64.
- Protezione contro l'accensione: sicurezza aumentata di tipo "e" e sicurezza costruttiva di tipo "c".

ACCESSORI

- AS - Griglia a gravità
- DSS - Regolatore 5 V
- MVS6 - Termistore PTC
- TMS - Termistore del relè
- TR - Trasformatori

DESCRIPTION

Designed to fulfil the safety requirements of European Directive 2014/34/EU for units and protective systems in potentially explosive atmospheres in zone 21 and 22. Explosion protection and approvals in accordance with ATEX and IECEx scheme.

For usage temperatures from -20°C to +60°C.

Can be switched to ventilation or air extraction.

Qualified for all dusts of the Ex-group IIIA and IIIB.

CONSTRUCTION

- Axial impeller made of conductive plastic.
- Balance quality of the motor/impeller combination G 6.3 according to category BV-3 in accordance with ISO 14694.
- Protective grille on the intake side, protection against accidental contact in accordance with DIN EN ISO 13857.
- Can be fitted in any position.

MOTOR

- Robust reversible three-phase AC motor with ball bearings, maintenance-free.
- Reversing mode: the volumetric flow is reduced by approx. 35% with reverse air flow direction.
- S1 operating mode (continuous operation).
- Speed control permitted with TR transformer (exception: DZQ 35/2 B Ex).
- The temperature in the fan motor is monitored by PTC thermistors.
- The MAICO PTC thermistor triggering device MVS 6 or TMS is recommended.
- IP 64 degree of protection.
- Types of ignition protection: "e" - increased safety and "c" - constructional safety.

ACCESSORIES

- AS - Gravity shutter
- DSS - 5-speed controller
- MVS6 - PTC thermistor
- TMS - Relay thermistor
- TR - Transformers

DZQ Ext 200

Code	Tipo Type	Modello Model	U	P	Pm (kW)	In (A)	IP/CL	Q max m ³ /h	LwA7 dB(A)*
1DZ2043	DZQ	20/4 B Ex t	T	4	0,03	0,19	64/F	540	59
1DZ2044		20/2 B Ex t	T	2	0,065	0,25	64/F	1.090	75

*Livello di potenza sonora in dB a bocca libera
Free inlet sound power level in dB

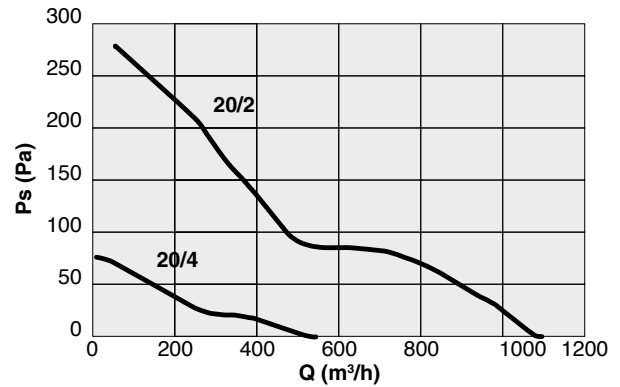

DZQ Ext 250

Code	Tipo Type	Modello Model	U	P	Pm (kW)	In (A)	IP/CL	Q max m ³ /h	LwA7 dB(A)*
1DZ2542	DZQ	25/4 B Ex t	T	4	0,038	0,19	64/F	950	65
1DZ2543		25/2 B Ex t	T	2	0,13	0,41	64/F	1.880	81

*Livello di potenza sonora in dB a bocca libera
Free inlet sound power level in dB

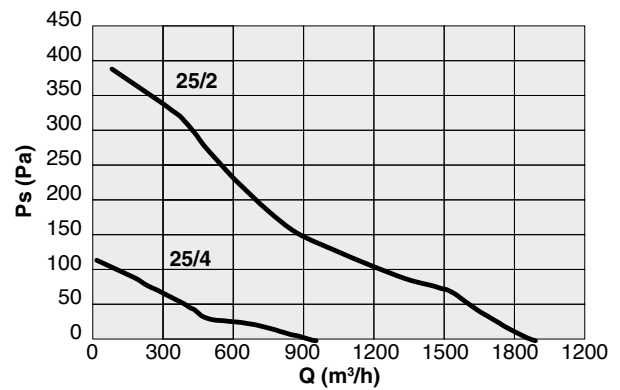

DZQ Ext 300

Code	Tipo Type	Modello Model	U	P	Pm (kW)	In (A)	IP/CL	Q max m ³ /h	LwA7 dB(A)*
1DZ3042	DZQ	30/6 B Ex t	T	6	0,025	0,13	64/F	1.100	60
1DZ3043		30/4 B Ex t	T	4	0,095	0,49	64/F	1.730	69
1DZ3044		30/2 B Ex t	T	2	0,24	0,85	64/F	3.380	86

*Livello di potenza sonora in dB a bocca libera
Free inlet sound power level in dB

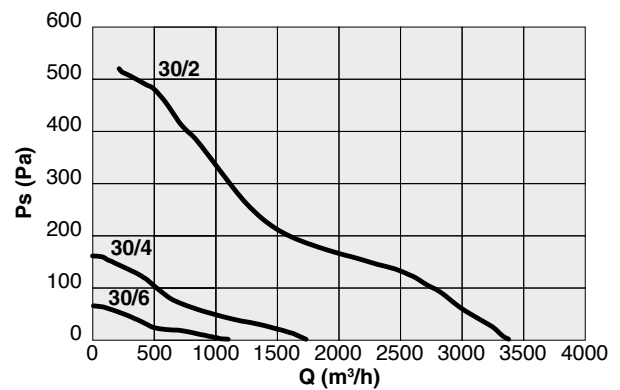

DZQ Ext 350

Code	Tipo Type	Modello Model	U	P	Pm (kW)	In (A)	IP/CL	Q max m ³ /h	LwA7 dB(A)*
1DZ3545	DZQ	35/6 B Ex t	T	6	0,035	0,15	64/F	1.750	64
1DZ3546		35/4 B Ex t	T	4	0,125	0,51	64/F	2.660	72
1DZ3547		35/2 B Ex t	T	2	0,58	1,96	64/F	5.460	90

*Livello di potenza sonora in dB a bocca libera
Free inlet sound power level in dB

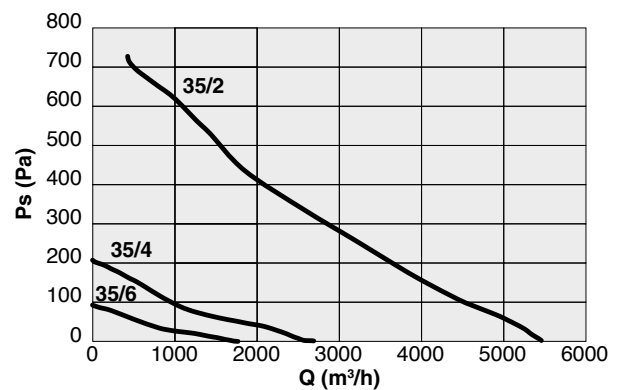

DZQ Ext 400

Code	Tipo Type	Modello Model	U	P	Pm (kW)	In (A)	IP/CL	Q max m ³ /h	LwA7 dB(A)*
1DZ4048	DZQ	40/6 B Ex t	T	6	0,095	0,56	64/F	2.740	68
1DZ4049		40/4 B Ex t	T	4	0,17	0,71	64/F	4.130	77

*Livello di potenza sonora in dB a bocca libera
Free inlet sound power level in dB

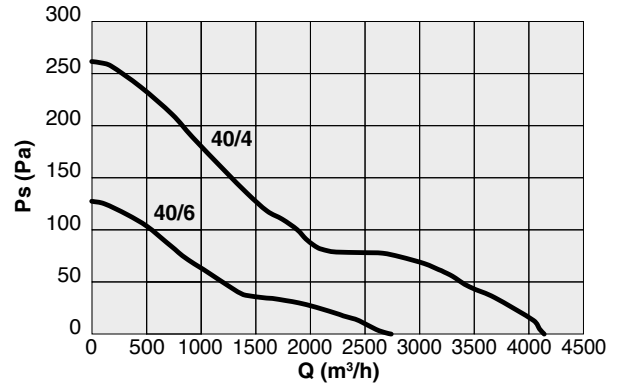

DZQ Ext 450

Code	Tipo Type	Modello Model	U	P	Pm (kW)	In (A)	IP/CL	Q max m ³ /h	LwA7 dB(A)*
1DZ4545	DZQ	45/6 B Ex t	T	6	0,14	0,62	64/F	4.240	72
1DZ4546		45/4 B Ex t	T	4	0,33	1,1	64/F	6.400	82

*Livello di potenza sonora in dB a bocca libera
Free inlet sound power level in dB

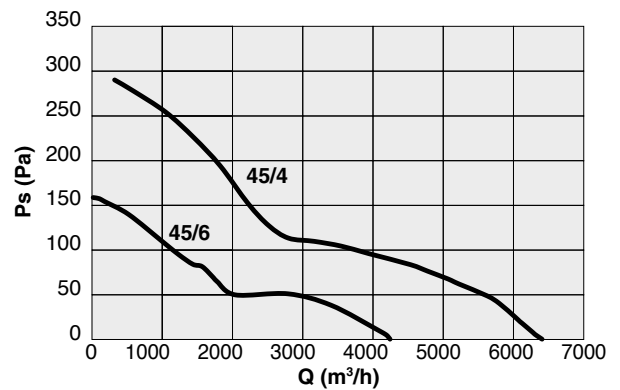

DZQ Ext 500

Code	Tipo Type	Modello Model	U	P	Pm (kW)	In (A)	IP/CL	Q max m ³ /h	LwA7 dB(A)*
1DZ5063	DZQ	50/6 B Ex t	T	6	0,165	0,73	64/F	5.320	73
1DZ5064		50/4 B Ex t	T	4	0,42	1,83	64/F	8.200	82

*Livello di potenza sonora in dB a bocca libera
Free inlet sound power level in dB

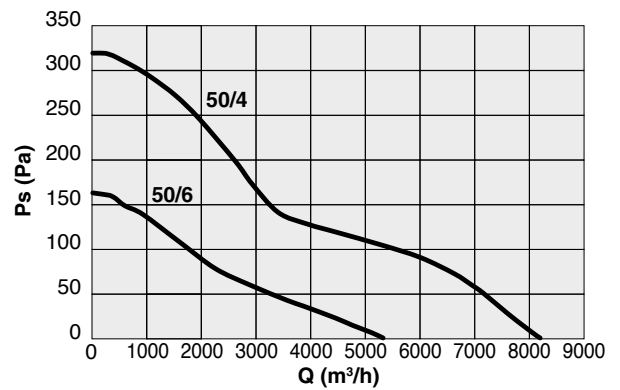

DZQ Ext 600

Code	Tipo Type	Modello Model	U	P	Pm (kW)	In (A)	IP/CL	Q max m ³ /h	LwA7 dB(A)*
1DZ6062	DZQ	60/6 B Ex t	T	6	0,295	1,32	64/F	9.450	78

*Livello di potenza sonora in dB a bocca libera
Free inlet sound power level in dB

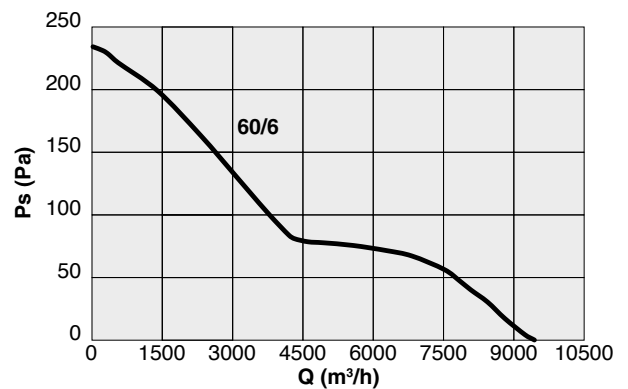

DZQ Ex t - EZQ EX t Con telaio quadro | With square wall plate **1**

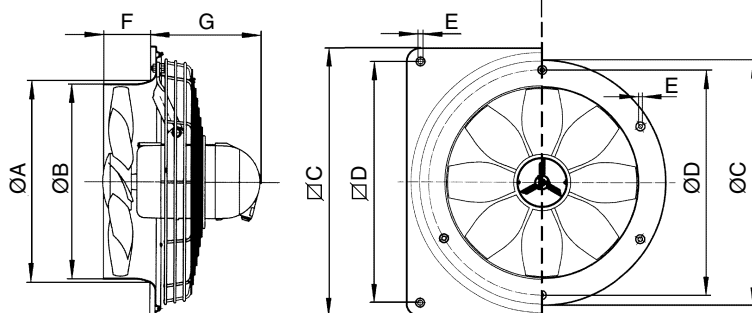

2 Con telaio tondo | With round frame DZS EX t - EZS Ex t

DZQ Ex t **1**

TIPO TYPE	ØA	ØB	ØC	ØD	E	F	G	Kg
DZQ Ex t 200 / EZQ Ex t 200*	216,7	215	345	305	8,5	44,5	176	7 / 3,95
DZQ Ex t 250	271,1	265	400	350	8,5	57,5	165	8
DZQ Ex t 300	326,9	315	465	405	11	72,5	183	12
DZQ Ex t 350	380,5	365	525	465	11	90,5	198	13
DZQ Ex t 400	430,8	417	580	520	11	100	172	15
DZQ Ex t 450	470	461	630	570	11	107	162	16
DZQ Ex t 500	542,7	516	700	640	11	137	156,5	22
DZQ Ex t 600	652,2	615	820	740	11	140	177,5	27

*Versione Monofase. Pesi indicativi | *Single-phase version. Indicative weights

DZS Ex t **2**

TIPO TYPE	ØA	ØB	ØC	ØD	E	F	G	Kg
DZS Ex t 200 / EZS Ex t 200*	218,9	215	297	250	10,4	60	176	6 / 3,36
DZS Ex t 250	271,6	263	353	306	10,4	80	165	7
DZS Ex t 300	330,4	313	420	370	10,4	95	183	10
DZS Ex t 350	386,6	364	476	428	10,4	95	198	10
DZS Ex t 400	442,6	414	533	485	10,4	109	172	12
DZS Ex t 500	556,1	514	650	602	10,4	138	156,5	17
DZS Ex t 600	666,9	614	772	724	10,4	138	177,5	29

*Versione Monofase. Pesi indicativi | *Single-phase version. Indicative weights



AS | GRIGLIA A GRAVITÀ | GRAVITY SHUTTER

Serrande per l'estrazione dell'aria.
Con griglia di protezione zincata.
Dalla taglia 35, con ponte centrale per
aumentare la stabilità delle lame.

Shutters for air extraction.
With galvanised protective grille.
From nominal size 35 with centre
bridge for increasing the stability of the
shutters.

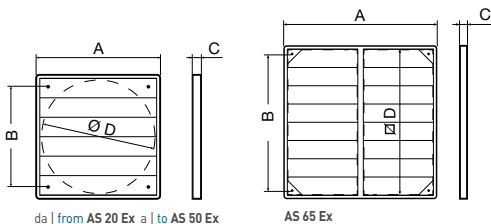

Code	Tipo Type	Modello Model	∅A	∅B	C	D
5SE0207	AS 20 Ex	DZQ 200	242	182	21	209
5SE0208	AS 25 Ex	DZQ 250	294	232	26	258
5SE0209	AS 30 Ex	DZQ 300	346	276	25	309
5SE0210	AS 35 Ex	DZQ 250	396	311	25	359
5SE0211	AS 40 Ex	DZQ 400	462	366	26	422
5SE0212	AS 45 Ex	DZQ 450	501	396	30	462
5SE0213	AS 50 Ex	DZQ 500	548	443	30	505
5SE0214	AS 65 Ex	DZQ 600	696	628	30	655

Dimensioni in mm | Dimensions in mm

DSS | REGOLATORE 5 VELOCITÀ AD AUTOTRASFORMATORE 5-STEP SWITCH SPEED TRANSFORMER

Adatto per motori AC.
Corrente max. 20 A.

Suited for AC fans
Max load 20 A



Code	Tipo Type	IP
5TR2006	DSS Vedi tabella abbinamento See Pairing table	00

MVS6 | TERMISTORE PTC | PTC THERMISTOR

Sistema completo indipendente.
Dispositivo di attivazione del termistore
PTC per il monitoraggio della
temperatura massima del motore.
Testato secondo la direttiva 2014/34/UE.
Con spia di funzionamento.
Installazione esclusivamente in aree
non esplosive.

Independent complete system.
PTC thermistor triggering device
for monitoring the maximum motor
temperature.
Type-examination tested according to
Directive 2014/34/EU.
With operating indicator light
Installation exclusively in non-explosive
areas.

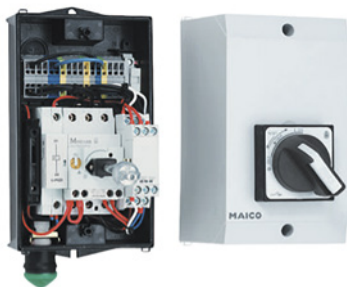

Code	Tipo Type	Modello Model	IP
5MV0004	MVS 6	DZQ 20/60	65

TMS | TERMISTORE DEL RELÈ | RELAY THERMISTOR

Termistore del relè di protezione della
macchina
Installazione esclusivamente in aree
non esplosive.

Machine protection relay thermistor
Installation exclusively in non-explosive
areas.



Code	Tipo Type	Modello Model	IP
5MV0003	TMS	DZQ 20/60	20



TR | TRASFORMATORI | TRANSFORMERS

TR 0,4-2
TR 0,8-2
TR 2,5-2



Tipo di installazione: montaggio in superficie
Type of installation: surface-mounted

TR 0,8 S-2
TR 2,5 S-2



Tipo di installazione: armadio di comando. **NB:** fornito a coppia
Type of installation: control cabinet. **NB:** packing unit 2pcs

Code	Tipo Type	Trifase Three-phase	Tensione nominale Rated voltage	Frequenza Frequency	Potenza nominale Nominal output	Carico massimo Maximum load	Grado di protezione Degree of protection	Tensione secondaria Secondary voltage	Peso Weight	Dimensioni Dimension
			V	Hz	W	A	IP	V	Kg	mm
5TR2004	TR 0,4-2	AC	400	50 / 60	200	0,4	54	105 / 150 / 190 / 250 / 400	3,3	248 x 205 x h195
5TR2005	TR 0,8 S-2	AC	400	50 / 60	144	0,8	00	105 / 150 / 190 / 250 / 400	3,9	84 x 75 x h95
5TR2007	TR 0,8-2	AC	400	50 / 60	400	0,8	54	105 / 150 / 190 / 250 / 400	5	248 x 205 x h195
5TR2008	TR 2,5-2	AC	400	50 / 60	1.250	2,5	54	105 / 150 / 190 / 250 / 400	10	228 x 225 x h310
5TR2009	TR 2,5 S-2	AC	400	50 / 60	450	2,5	00	105 / 150 / 190 / 250 / 400	8	120 x 120 x h90

Dimensioni in mm | Dimensions in mm

TABELLA ABBINAMENTO | PAIRING TABLE

Tipo Type	Code	DSS	MVS 6	TMS	TR 0,4-2	TR 0,8-2	TR 0,8 S-2	TR 2,5-2	TR 2,5 S-2
e / t		5TR2006	5MV0004	5MV0003	5TR2004	5TR2007	5TR2005	5TR2008	5TR2009
DZQ 20/2 B ex e/t	1DZ2021 / 1DZ2044	✓	✓	✓	✓		✓		
DZQ 20/4 B ex e/t	1DZ2022 / 1DZ2043	✓	✓	✓	✓		✓		
DZQ 25/2 B ex e/t	1DZ2523 / 1DZ2543	✓	✓	✓	✓		✓		
DZQ 25/4 B ex e/t	1DZ2522 / 1DZ2542	✓	✓	✓	✓		✓		
DZQ 30/2 B ex e/t	1DZ3025 / 1DZ3044	✓	✓	✓				✓	✓
DZQ 30/4 B ex e/t	1DZ3024 / 1DZ3043	✓	✓	✓		✓	✓		
DZQ 30/6 B ex e/t	1DZ3023 / 1DZ3042	✓	✓	✓		✓	✓		
DZQ 35/2 B ex e/t	1DZ3541 / 1DZ3547	✓	✓	✓					
DZQ 35/4 B ex e/t	1DZ3540 / 1DZ3546	✓	✓	✓		✓	✓		
DZQ 35/6 B ex e/t	1DZ3522 / 1DZ3545	✓	✓	✓		✓	✓		
DZQ 40/4 B ex e/t	1DZ4047 / 1DZ4049	✓	✓	✓		✓	✓		
DZQ 40/6 B ex e/t	1DZ4041 / 1DZ4048	✓	✓	✓		✓	✓		
DZQ 45/4 B ex e/t	1DZ4542 / 1DZ4546	✓	✓	✓		✓	✓		
DZQ 45/6 B ex e/t	1DZ4541 / 1DZ4545	✓	✓	✓	✓	✓			
DZQ 50/4 B ex e/t	1DZ5043 / 1DZ5064	✓	✓	✓				✓	✓
DZQ 50/6 B ex e/t	1DZ5042 / 1DZ5063	✓	✓	✓		✓	✓		
DZQ 60/6 B ex e/t	1DZ6041 / 1DZ6062	✓	✓	✓		✓	✓		

NB: accessori non contemplati nel **Certificato di Esame del Tipo**. Contattare il servizio tecnico-commerciale per esigenze costruttive diverse.
NB: accessories not included in the **Type Examination Certificate**. Please contact us for any different construction requirements.