



DZR Ex e

Aspiratore assiale intubato Axial duct fan



Ex II 2G Ex eb IIB+H2 T3/T4 Gb X /
Ex II 2G Ex h IIB+H2 T3/T4 Gb X
GAS / HYDROGEN

NORME | NORMS

IEC 60079-0
IEC 60079-31
IEC 60079-7
ISO 80079-36
ISO 80079-37
EN ISO 80079-36
EN ISO 80079-37

Attestato di Esame del Tipo Type Examination Statement



TÜV-A 19 ATEX0103 X, IECEx EPS 19.0019X

A RICHIESTA UPON REQUEST

- Versioni a 60 Hz
- Versions at 60 Hz

VERSIONI | VERSIONS



DZR Ex t

Ex II 2D Ex tb IIIB T135°C/T200°C Db IP64 X
Ex II 2D Ex h IIIB T135°C/T200°C Db X
DUST

DESCRIZIONE

Progettati per garantire un elevato fattore di sicurezza contro le esplosioni nelle zone 1 e 2, in conformità alla Direttiva ATEX 2014/34/UE e allo schema IECEx.

Commutabile in ventilazione o estrazione dell'aria.

Indicato per tutti i gas e i vapori dei gruppi Ex IIA e IIB e anche per l'idrogeno.

Temperature di utilizzo da -20°C a +40°C.

COSTRUZIONE

- Girante assiale in plastica conduttiva.
- Grado di equilibratura G 6.3 secondo la categoria BV-3 in conformità alla norma ISO 14694.
- Cassa in lamiera d'acciaio zincata.

MOTORE

Robusto motore trifase dotato di cuscinetti a sfera, esente da manutenzione.

Reversibilità: la portata volumetrica si riduce di circa il 35% in caso di direzione invertita del flusso d'aria.

Modalità di funzionamento S1 (servizio continuo). Regolabile tramite regolatori della serie TR (ad eccezione del DZR 35/2 B Ex).

Motore dotato di sistemi di protezione da sovratemperatura con termistori tipo PTC.

Sistema di protezione consigliato: PTC MAICO MVS 6 o TMS. Grado di protezione IP 64.

Protezione contro l'accensione: sicurezza aumentata di tipo "e" e sicurezza costruttiva di tipo "c".

ACCESSORI

- EL Ex - Giunto flessibile
- AD - Bocca di aspirazione
- AS - Griglia a gravità
- DDEx - Pressostato differenziale
- DSS - Regolatore 5 V
- ELA - Giunto flessibile
- FU - Piedi di montaggio
- GF - Controflangia
- GP - Ammortizzatore di vibrazioni
- GS - Contro-accoppiamento
- MVS6 - Quadro controllo termistore PTC
- SG - Griglia di protezione
- TMS - Relè di protezione termistore
- TR - Trasformatori

DESCRIPTION

MAICO Ex fans fulfil the safety requirements of European Directive 2014/34/EU for units and protective systems in potentially explosive atmospheres. Explosion protection and approvals in accordance with ATEX and IECEx.

Can be switched to ventilation or air extraction. Qualified for all gases and vapours of Ex group IIA and IIB and also for hydrogen.

For usage temperatures from -20°C to +40°C.

CONSTRUCTION

- Axial impeller made of conductive plastic.
- Balance quality of the motor/impeller combination G 6.3 according to category BV-3 in accordance with ISO 14694.
- Short casing in steel sheet

MOTOR

Robust reversible three-phase AC motor with ball bearings, maintenance-free.

Reversing mode: the volumetric flow is reduced by approx. 35% with abnormal air flow direction.

S1 operating mode (continuous operation). Speed control permitted with TR transformer (exception: DZR 35/2 B Ex). The temperature in the fan motor is monitored by PTC thermistors.

The MAICO PTC thermistor triggering device MVS 6 or TMS is recommended as the triggering system. IP 64 degree of protection. Types of ignition protection: "e" - increased safety and "c" - constructional safety.

ACCESSORIES

- EL Ex - Flexible cuff
- AD - Suction nozzle
- AS - Shutter
- DDEx - Differential pressure switch
- DSS - 5-step speed transformer
- ELA - Flexible coupling
- FU - Mounting foot
- GF - Counterflange
- GP - Vibration damper
- GS - Counter socket
- MVS6 - PTC thermistor triggering device
- SG - Protection grille
- TMS - Thermistor overload relay
- TR - Transformers

DZR Ex e 200

Code	Tipo Type	Modello Model	U	P	Pm (kW)	In (A)	IP/CL	Q max m³/h	LwA7 dB(A)
1DR2023	DZR	20/2 B Ex e	T	2	0,065	0,25	64/F	1.050	80

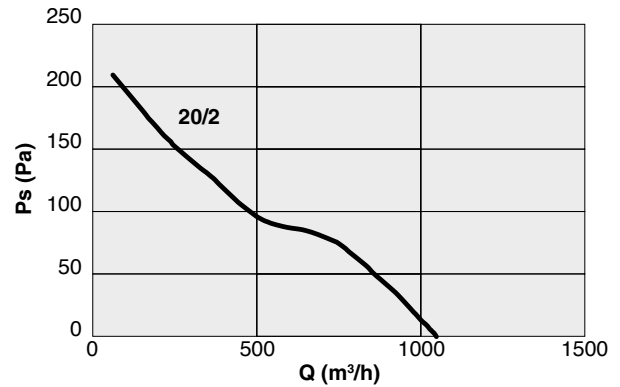

DZR Ex e 250

Code	Tipo Type	Modello Model	U	P	Pm (kW)	In (A)	IP/CL	Q max m³/h	LwA7 dB(A)
1DR2522	DZR	25/4 B Ex e	T	4	0,038	0,19	64/F	980	65
1DR2523		25/2 B Ex e	T	2	0,13	0,40	64/F	1.950	81

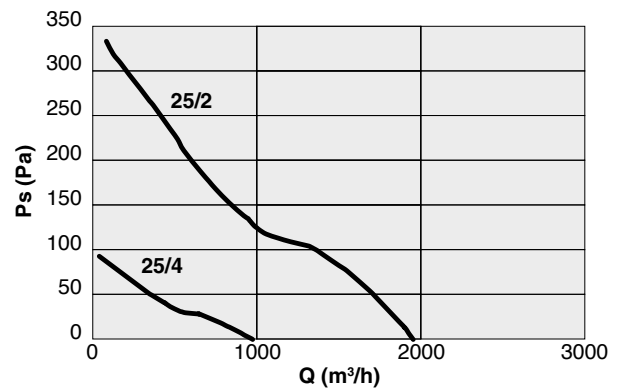

DZR Ex e 300

Code	Tipo Type	Modello Model	U	P	Pm (kW)	In (A)	IP/CL	Q max m³/h	LwA7 dB(A)
1DR3043	DZR	30/6 B Ex e	T	6	0,025	0,13	64/F	1.130	58
1DR3044		30/4 B Ex e	T	4	0,095	0,49	64/F	1.760	66
1DR3045		30/2 B Ex e	T	2	0,24	0,89	64/F	3.410	85

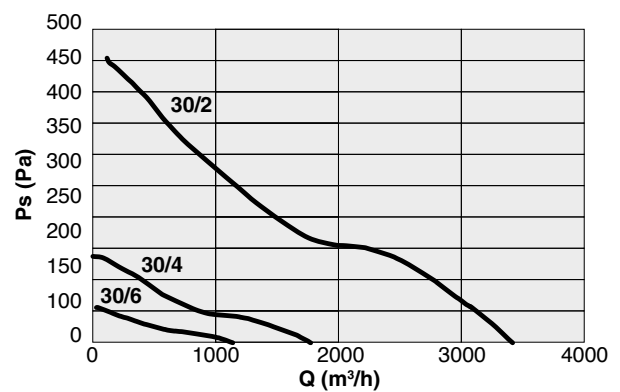

DZR Ex e 350

Code	Tipo Type	Modello Model	U	P	Pm (kW)	In (A)	IP/CL	Q max m³/h	LwA7 dB(A)
1DR3502	DZR	35/6 B Ex e	T	6	0,035	0,16	64/F	1.700	58
1DR3501		35/4 B Ex e	T	4	0,125	0,50	64/F	2.650	72
1DR3500		35/2 B Ex e	T	2	0,53	1,94	64/F	5.230	89

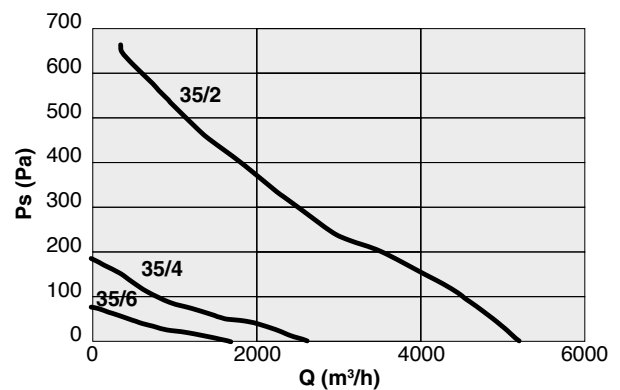

DZR Ex e 400

Code	Tipo Type	Modello Model	U	P	Pm (kW)	In (A)	IP/CL	Q max m ³ /h	LwA7 dB(A)
1DR4060	DZR	40/6 B Ex e	T	6	0,095	0,55	64/F	2.770	66
1DR4061		40/4 B Ex e	T	4	0,17	0,74	64/F	4.200	76

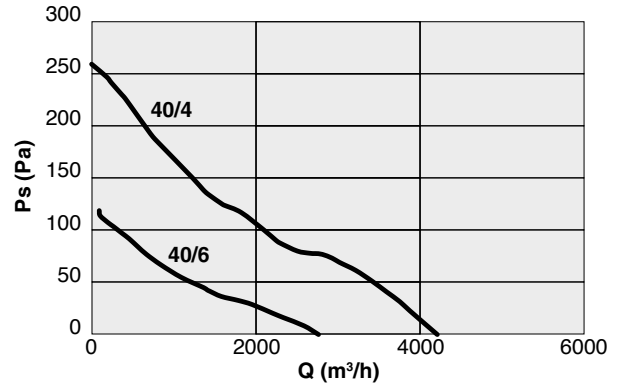

DZR Ex e 450

Code	Tipo Type	Modello Model	U	P	Pm (kW)	In (A)	IP/CL	Q max m ³ /h	LwA7 dB(A)
1DR4560	DZR	45/6 B Ex e	T	6	0,15	0,61	64/F	4.160	69
1DR4561		45/4 B Ex e	T	4	0,35	1,02	64/F	6.200	78

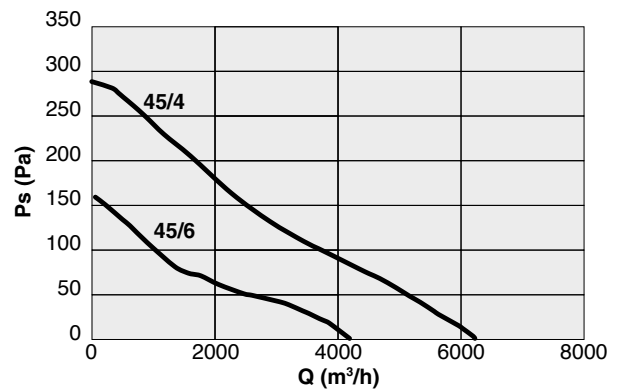

DZR Ex e 500

Code	Tipo Type	Modello Model	U	P	Pm (kW)	In (A)	IP/CL	Q max m ³ /h	LwA7 dB(A)
1DR5060	DZR	50/6 B Ex e	T	6	0,174	0,74	64/F	5.520	71
1DR5061		50/4 B Ex e	T	4	0,445	1,71	64/F	8.190	82

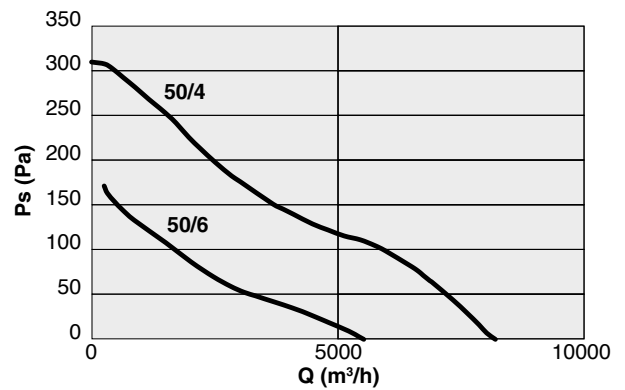

DZR Ex e 600

Code	Tipo Type	Modello Model	U	P	Pm (kW)	In (A)	IP/CL	Q max m ³ /h	LwA7 dB(A)
1DR6041	DZR	60/6 B Ex e	T	6	0,295	1,25	64/F	9.370	77

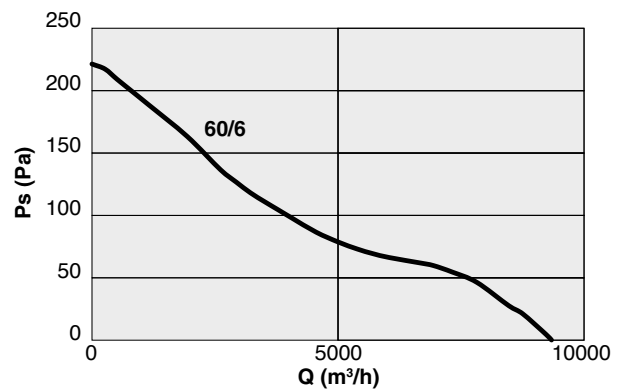

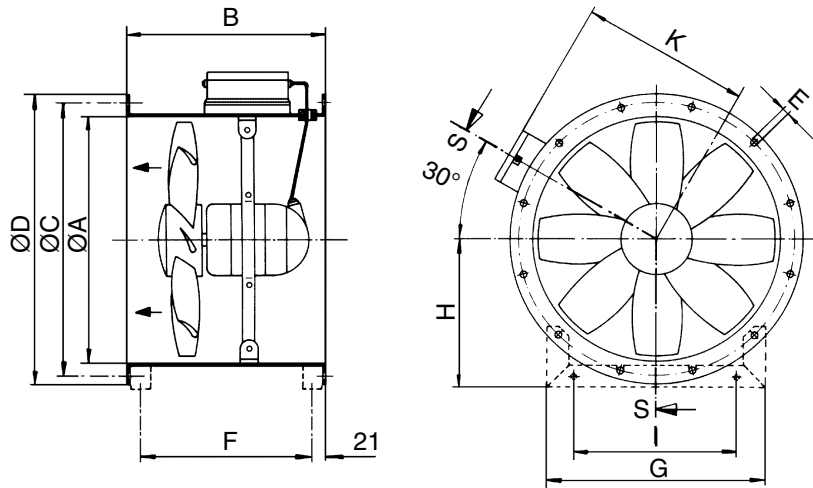

DZR Ex e

TIPO TYPE	ØA	B	ØC	ØD	E	F	G	H	I	K	Kg
DZR Ex e 200	213	240	235	254	7	193	243	152	150	165	7
DZR Ex e 250	263	300	286	304	7	255	288	178	150	194	8,60
DZR Ex e 300	313	300	356	380	9	255	292	203	200	221	12
DZR Ex e 350	363	320	395	420	9	275	319	226	224	248	13
DZR Ex e 400	413	370	438	460	9	325	350	249	250	274	14
DZR Ex e 450	458	310	487	510	9	255	385	274	280	297	15
DZR Ex e 500	513	370	541	565	9	325	423	299	315	325	22
DZR Ex e 600	613	400	674	710	11	355	517	369	400	376	30

Numero di fori della flangia: 6 | Number of flange holes: 6
 Pesì indicativi | Indicative weights



EL Ex | GIUNTO FLESSIBILE | FLEXIBLE CUFF

Giunto flessibile in plastica con 2 cinghie di tensionamento insonorizzante e antivibrante

Flexible cuff with 2 tensioning straps for sound and vibration damped assembly duct fans, plastic

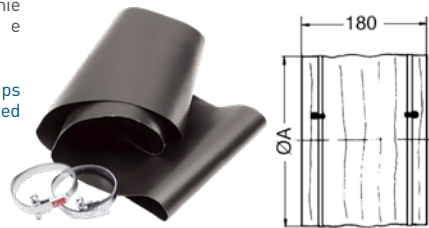

Code	Tipo Type	ØA
5EL0008	EL 20 Ex	213
5EL0009	EL 25 Ex	263
5EL0010	EL 30 Ex	313
5EL0011	EL 35 Ex	363
5EL0012	EL 40 Ex	413
5EL0013	EL 45 Ex	458
5EL0014	EL 50 Ex	513

EL 60 Ex: non disponibile | not available
Dimensioni in mm | Dimensions in mm

AD | BOCCA DI ASPIRAZIONE | SUCTION NOZZLE

Bocca di spirazione anti-turbolenze, in lamiera zincata.

Suction nozzle for turbulence-reduced air intake, sheet steel, galvanised.

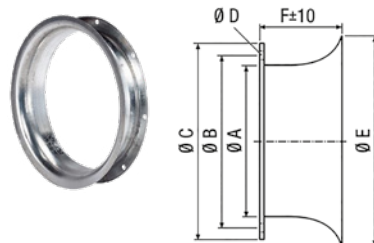

Code	Tipo Type	ØA	ØB	ØC	ØD	ØE	F
5AD2001	AD 20	213	235	254	8	265	110
5AD2002	AD 25	263	286	314	7,5	335	110
5AD2003	AD 30	313	356	380	10	385	100
5AD2004	AD 35	363	395	420	10	435	100
5AD2005	AD 40	413	438	460	10	485	100
5AD2006	AD 45	458	487	510	10	535	100
5AD2008	AD 50	513	541	565	10	585	100
5AD2008	AD 60	613	676	710	14	700	90

Dimensioni in mm | Dimensions in mm

AS | GRIGLIA A GRAVITÀ | GRAVITY SHUTTER

Serrande per l'estrazione dell'aria. Con griglia di protezione zincata. Dalla taglia 35, con ponte centrale per aumentare la stabilità delle lame.

Shutters for air extraction. With galvanised protective grille. From nominal size 35 with centre bridge for increasing the stability of the shutters.

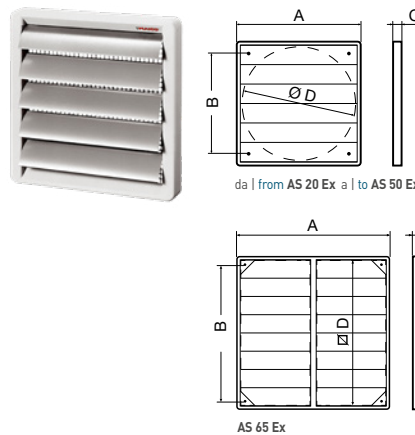

Code	Tipo Type	Modello Model	ØA	ØB	C	D
5SE0207	AS 20 Ex	DZR 200	242	182	21	209
5SE0208	AS 25 Ex	DZR 250	294	232	26	258
5SE0209	AS 30 Ex	DZR 300	346	276	25	309
5SE0210	AS 35 Ex	DZR 250	396	311	25	359
5SE0211	AS 40 Ex	DZR 400	462	366	26	422
5SE0212	AS 45 Ex	DZR 450	501	396	30	462
5SE0213	AS 50 Ex	DZR 500	548	443	30	505
5SE0214	AS 65 Ex	DZR 600	696	628	30	655

Dimensioni in mm | Dimensions in mm

DDEx | PRESSOSTATO DIFFERENZIALE | DIFFERENTIAL PRESSURE SWITCH

Pressostato differenziale per la determinazione della differenza di pressione tra due valori di pressione compresi tra 0 - 500 Pa.

Il pressostato può essere parametrizzato in loco, utilizzando il menu di navigazione, senza ulteriori ausili elettronici.

Il punto di commutazione è liberamente scalabile nell'intervallo di impostazione 25 - 500 Pa.

Differential pressure switch for determining the pressure difference between two pressure values between 0 - 500 Pa.

The pressure switch can be parameterised on site, using the menu navigation, without additional electronic aids.

The switching point is freely scalable within the setting range 25 - 500.



Code	Misure Size
------	---------------

5DD0000 107 x 180 x 66

Dimensioni in mm | Dimensions in mm



DSS | REGOLATORE 5 VELOCITÀ AD AUTOTRASFORMATORE 5-STEP SWITCH SPEED TRANSFORMER

Adatto per motori AC.
Corrente max. 20 A.

Suited for AC fans.
Max load 20 A.



Code	Tipo Type	IP
5TR2006	DSS Vedi tabella abbinamento See Pairing table	00

ELA Ex | GIUNTO FLESSIBILE | FLEXIBLE COUPLING

Giunto flessibile per il collegamento smorzato di condotti di ventilazione.
Adatto per l'uso in aree soggette a rischio di esplosione.

Flexible coupling for the sound and vibration damped connection of ventilation ducts.
Suitable for use in areas subject to explosion hazards.

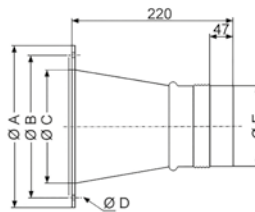

Code	Tipo Type	ØA	ØB	ØC	ØD	ØE
5EL0000	ELA 20 Ex	254	235	212	7	198
5EL0001	ELA 25 Ex	304	286	262	7	247
5EL0002	ELA 30 Ex	380	356	312	9,5	297
5EL0003	ELA 35 Ex	420	395	362	9,5	347
5EL0004	ELA 40 Ex	460	438	412	9,5	397
5EL0006	ELA 50 Ex	565	541	512	9,5	497
5EL0007	ELA 60 Ex	710	674	612	14	597

Dimensioni in mm | Dimensions in mm

FU | PIEDI DI MONTAGGIO | MOUNTING FOOT

Piedini di montaggio per l'installazione dei ventilatori EZR/DZR su pareti, soffitti o staffe.

Mounting foot for the assembly of EZR/DZR fans on walls, ceilings or brackets.

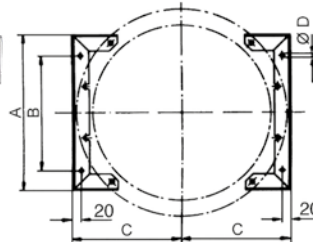

Code	Tipo Type	A	B	C	ØD
5FU2002	FU 20	243	150	152	7
5FU2003	FU 25	288	150	178	7
5FU2004	FU 30	292	200	203	7
5FU2005	FU 35	319	224	226	7
5FU2006	FU 40	350	250	249	7
5FU2007	FU 45	385	280	274	7
5FU2008	FU 50	423	315	299	11
5FU2010	FU 60	517	400	345	11

Dimensioni in mm | Dimensions in mm

GF | CONTROFLANGIA | COUNTER-FLANGE

Controflangia per il montaggio su condotto.

Counter flange for the assembly of fans to ventilation ducts.

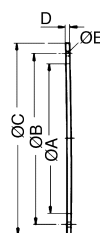

Code	Tipo Type	ØA	ØB	ØC	D	ØE
5RE2134	GF 20	213	235	254	5	7
5GF2002	GF 25	263	286	304	5	7
5GF2003	GF 30	313	356	380	6	9,5
5GF2004	GF 35	363	395	420	6	9,5
5GF2005	GF 40	413	438	460	6	9,5
5GF2006	GF 45	458	487	510	6	9,5
5GF2007	GF 50	513	514	565	6	9,5

GF 60: non disponibile | not available
Dimensioni in mm | Dimensions in mm



GP | AMMORTIZZATORE DI VIBRAZIONI | VIBRATION DAMPER

4 smorzatori di vibrazioni .

4 vibration dampers .



Code	Tipo Type	Modello Model	A	B	C	ØD	ØE	F	G	H	I
5GP1001	GP 10	DZR 20/40	45	60	35	6	30	M6	5	18	1
5GP1002	GP 20	DZR 45/60	70	90	50	9	45	M10	8	29	1,5

Dimensioni in mm | Dimensions in mm

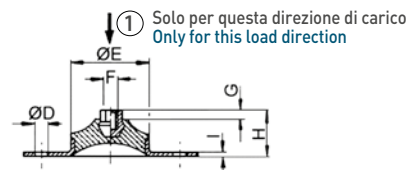
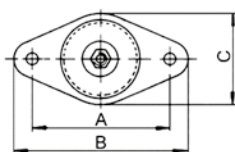

GS | CONTRO-ACCOPIAMENTO | COUNTER SOCKET

Contro-accoppiamento per il montaggio del giunto flessibile sul condotto.

Counter socket for fitting flexible cuffs on ventilation ducts.

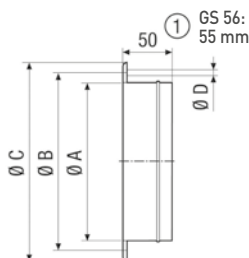

Code	Tipo Type	ØA	ØB	ØC	ØD
5GS2001	GS 20	210	235	254	8
5GS2002	GS 25	263	286	304	8
5GS2003	GS 30	313	356	380	10
5GS2004	GS 35	363	395	420	10
5GS2005	GS 40	413	438	460	10
5GS2006	GS 45	458	487	512	10
5GS2007	GS 50	513	541	565	10
5GS2009	GS 60	613	674	710	14

Dimensioni in mm | Dimensions in mm

MVS6 | QUADRO CONTROLLO TERMISTORE PTC | PTC THERMISTOR TRIGGERING DEVICE

Sistema completo indipendente. Dispositivo di attivazione del termistore PTC per il monitoraggio della temperatura massima del motore. Testato secondo la direttiva 2014/34/UE. Con spia di funzionamento. Installazione esclusivamente in aree non esplosive.

Independent complete system. PTC thermistor triggering device for monitoring the maximum motor temperature. Type-examination tested according to Directive 2014/34/EU. With operating indicator light Installation exclusively in non-explosive areas.

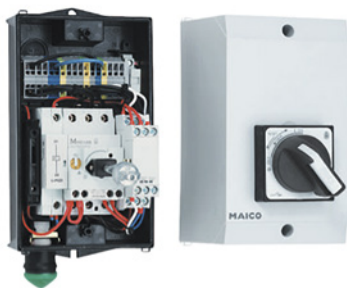

Code	Tipo Type	Modello Model	IP
5MV0004	MVS 6	DZQ 20/60	65

SG | GRIGLIA DI PROTEZIONE | SAFETY GRILLE

Griglia di protezione in metallo.

Safety grille in metal.

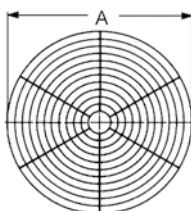

Code	Tipo Type	ØA
5RE2134	SG 20	248
5RE2135	SG 25	297
5RE2136	SG 30	369
5RE2137	SG 35	410
5RE2138	SG 40	455
5RE2140	SG 50	558
5RE2142	SG 60	698

Dimensioni in mm | Dimensions in mm



TMS | RELE DI PROTEZIONE TERMISTORE | THERMISTOR OVERLOAD RELAY

Installazione esclusivamente in aree non esplosive.

Installation exclusively in non-explosive areas.



Code	Tipo Type	Modello Model	IP
5MV0003	TMS	DZR 20/60	20

TR | TRASFORMATORI | TRANSFORMERS

TR 0,4-2
TR 0,8-2
TR 2,5-2



Tipo di installazione: montaggio in superficie
Type of installation: surface-mounted

TR 0,8 S-2
TR 2,5 S-2



Tipo di installazione: armadio di comando. NB: fornito a coppia
Type of installation: control cabinet. NB: packing unit 2pcs

Code	Tipo Type	Trifase Three-phase	Tensione nominale Rated voltage	Frequenza Frequency	Potenza nominale Nominal output	Carico massimo Maximum load	Grado di protezione Degree of protection	Tensione secondaria Secondary voltage	Peso Weight	Dimensioni Dimension
			V	Hz	W	A	IP	V	Kg	mm
5TR2004	TR 0,4-2	AC	400	50 / 60	200	0,4	54	105 / 150 / 190 / 250 / 400	3,3	248 x 205 x h195
5TR2005	TR 0,8 S-2	AC	400	50 / 60	144	0,8	00	105 / 150 / 190 / 250 / 400	3,9	84 x 75 x h95
5TR2007	TR 0,8-2	AC	400	50 / 60	400	0,8	54	105 / 150 / 190 / 250 / 400	5	248 x 205 x h195
5TR2008	TR 2,5-2	AC	400	50 / 60	1.250	2,5	54	105 / 150 / 190 / 250 / 400	10	228 x 225 x h310
5TR2009	TR 2,5 S-2	AC	400	50 / 60	450	2,5	00	105 / 150 / 190 / 250 / 400	8	120 x 120 x h90

Dimensioni in mm | Dimensions in mm

TABELLA ABBINAMENTO | PAIRING TABLE

Tipo Type	Code	DDEX	DSS 20	MVS 6	TMS	TR 0,4-2	TR 0,8-2	TR 0,8 S-2	TR 2,5-2	TR 2,5 S-2
	e / t	5DD0000	5TR2006	5MV0004	5MV0003	5TR2004	5TR2007	5TR2005	5TR2008	5TR2009
DZR 20/2 B Ex e / t	1DR2023 / 1DR2024	✓	✓	✓	✓	✓		✓		
DZR 25/2 B Ex e / t	1DR2523 / 1DR2525	✓	✓	✓	✓	✓		✓		
DZR 25/4 B Ex e / t	1DR2522 / 1DR2524	✓	✓	✓	✓	✓		✓	✓	✓
DZR 30/2 B Ex e / t	1DR3045 / 1DR3048	✓	✓	✓	✓					
DZR 30/4 B Ex e / t	1DR3044 / 1DR3047	✓	✓	✓	✓		✓	✓		
DZR 30/6 B Ex e / t	1DR3043 / 1DR3046	✓	✓	✓	✓		✓	✓		
DZR 35/2 B Ex e / t	1DR3500 / 1DR3505	✓	✓	✓	✓					
DZR 35/4 B Ex e / t	1DR3501 / 1DR3504	✓	✓	✓	✓		✓	✓		
DZR 35/6 B Ex e / t	1DR3502 / 1DR3503	✓	✓	✓	✓		✓	✓		
DZR 40/4 B Ex e / t	1DR4061 / 1DR4063	✓	✓	✓	✓		✓	✓		
DZR 40/6 B Ex e / t	1DR4060 / 1DR4062	✓	✓	✓	✓		✓	✓		
DZR 45/4 B Ex e / t	1DR4561 / 1DR4563	✓	✓	✓	✓		✓	✓		
DZR 45/6 B Ex e / t	1DR4560 / 1DR4562	✓	✓	✓	✓		✓	✓		
DZR 50/4 B Ex e / t	1DR5061 / 1DR5063	✓	✓	✓	✓				✓	✓
DZR 50/6 B Ex e / t	1DR5060 / 1DR5062	✓	✓	✓	✓		✓	✓		
DZR 60/6 B Ex e / t	1DR6041 / 1DR6042	✓	✓	✓	✓		✓	✓		

NB: accessori non contemplati nel Certificato di Esame del Tipo. Contattare il servizio tecnico-commerciale per esigenze costruttive diverse.
NB: accessories not included in the Type Examination Certificate. Please contact us for any different construction requirements.