



FCP ATEX - Flusso orizzontale
Horizontal discharge



FCP-V ATEX - Flusso verticale
Vertical discharge

NORME | NORMS

EN 14986:2017
EN 1127-1
EN ISO 80079-36
EN ISO 80079-37

Attestato di Esame del Tipo
Type Examination Statement



IMQ 24 ATEX 082 X

A RICHIESTA UPON REQUEST

- Versioni a 60 Hz
- Classi di temperatura T5 e T6
- Versions at 60 Hz
- Temperature classes T5 and T6

VERSIONI | VERSIONS



FCP - FCP-V ATEX
Zone 1
II2G Ex h IIB T4 Gb
GAS



FCP - FCP-V ATEX
Zone 1
II2G Ex IIB+H2 T4 Gb
HYDROGEN

FCP ATEX - FCP-V ATEX

Torrini centrifughi ad alte prestazioni High performance centrifugal roof fans



Zona 21 II2D Ex h IIB T 135°C Db
DUST

DESCRIZIONE

I torrini d'estrazione centrifughi delle serie FCP ATEX (flusso orizzontale) e FCP-V ATEX (flusso verticale) sono costruiti e certificati in conformità alla Direttiva ATEX 2014/34/UE.

Sono specificatamente progettati per poter essere utilizzati in zona 21, ossia in aree o ambienti dove sia necessario garantire un elevato fattore di sicurezza contro le esplosioni dovute alla presenza di polveri combustibili (II2D).

Il loro impiego è previsto per convogliare aria pulita con temperature comprese in un range da -20°C a +60°C (su richiesta, da -40°C a +60°C). Sono utilizzati negli impianti di ventilazione industriale (sia diretta che canalizzata) per il ricambio dell'aria e si prestano al montaggio a tetto su cavedio.

CONSTRUZIONE

- Telaio di base in lamiera d'acciaio zincato.
- Rete di protezione in lamiera zincata microstirata protetta contro gli agenti atmosferici. Realizzata a norme EN ISO 12499:2010 e UNI 80079-37-2016.
- Girante a pale rovesce autopulenti, ad alto rendimento aeraulico e bassa rumorosità, in lamiera zincata, bilanciata staticamente e dinamicamente secondo ISO 21940-11:2017.
- Copertura in ABS, con idonee feritoie per il corretto raffreddamento del motore.
- FCP-V ATEX: convogliatore in ABS.

MOTORE

Motore antideflagrante asincrono trifase o monofase a norme internazionali IEC 60034, IEC 60072, ATEX 2014/34/UE, EMC 2014/30/UE, LVD 2014/35/UE, marcato CE, IP66 secondo la EN ISO 20653, classe F. Idoneo ad un servizio continuo (S1). Specificamente progettato per installazione in ambienti classificati come zona ATEX 21 II2D (POLVERI) IIIC, apparecchiature protette mediante custodie con requisiti di tenuta alla penetrazione della polvere "tb" in accordo allo standard CEI EN IEC 60079-0, CEI EN 60079-31. Motore dotato di sistema di protezione da sovratemperatura con termistori tipo PTC conformi alle norme DIN 44081, DIN 44082, IEC 60034-11-2 e idoneo alla regolazione di velocità a mezzo di regolatore tipo inverter (per la versione trifase).

ACCESSORI

- TS - Serranda a gravità in aspirazione
- GR - Silenziatore
- CB - Controbases a murare
- BA - Basi d'appoggio su coperture ondulate
- Interruttore di servizio ATEX
- PB - Base d'appoggio/riduzione silenziosa
- CCr - Rete di protezione piana.

DESCRIPTION

The centrifugal roof fans of the FCP ATEX (horizontal discharge) and FCP-V ATEX (vertical discharge) series are built and certified in compliance with the ATEX Directive 2014/34/EU.

They are specifically designed to be used in zone 21, i.e. in areas or environments where it is necessary to guarantee a high safety factor against explosions due to the presence of combustible dusts (II2D).

They are suitable to convey clean air with a temperature included in a range from -20°C to +60°C (on request, from -40°C to +60°C). They are used in industrial ventilation systems (both direct and ducted) for air exchange and are suitable for roof mounting on a shaft.

CONSTRUCTION

- Base frame in galvanized steel sheet.
- Protection guard in micro-stretched galvanized sheet protected against atmospheric agents. Made according to EN ISO 12499: 2010 and UNI 80079-37-2016 standards.
- Impeller with self-cleaning backward blades, with high aeraulic efficiency and low noise, in galvanized sheet, statically and dynamically balanced according to ISO 21940-11:2017.
- ABS cover, with suitable slots for correct engine cooling.
- ABS conveyor on FCP-V ATEX.

MOTOR

Explosion-proof asynchronous three-phase or single-phase motor compliant with international standards IEC 60034, IEC 60072, ATEX 2014/34/UE, EMC 2014/30/EU, LVD 2014/35/EU, CE marked, IP66 to EN ISO 20653, class F. Suitable for continuous service (S1). Specifically designed for installation in environments classified as ATEX zone 21 II2D (DUST) IIIC, equipment protected by enclosures with dust penetration tightness requirements "tb" according to CEI EN IEC 60079-0, CEI EN 60079-31. The motor includes an overtemperature protection system equipped with PTC thermistors in accordance with DIN 44081, DIN 44082, IEC 60034-11-2 and suitable for speed regulation by inverter-type controller (for three-phase version).

ACCESSORIES

- TS - Backdraught gravity shutter
- GR - Silencer
- CB - Counterbase to wall up
- BA - Support base for waved roof coverings
- ATEX service switch
- PB - Support base/Silenced reduction
- CCr - Flat protection guard.

PRESTAZIONI | PERFORMANCE

FCP ATEX | FCP-V ATEX D

Le prestazioni aerauliche sono rilevate in conformità alla norma EN ISO 5801/AMCA 210 con densità dell'aria standard avente peso specifico 1,2 Kg/m³.
Il livello di potenza sonora è ottenuto secondo la norma AMCA 300-08 in camera riverberante. Installazione C.
Le tolleranze sono conformi alla ISO 13348 e alla DIN 24166.
Alimentazione 230V/1Ph/50Hz o 400V/3Ph/50Hz.

Air performances are measured according to EN ISO 5801 / AMCA 210 standard with air density with 1.2 kg/m³ specific weight.
The sound power level is obtained according to AMCA 300-08 in reverberating room. Installation C.
Tolerances comply with ISO13348 and DIN 24166.
Power supply 230V/1Ph/50Hz or 400V/3Ph/50Hz

FCP - FCP-V ATEX D 350

Code	Tipo Type	Modello Model	U	P	Pm (kW)	In (A)	IP/CL	IE3	Mot. (Gr)
1XF0009	FCP ATX	354 3600 0,25 kW	M	4	0,25	1,75	66/F	-	71
1XV0009	FCP-V ATX								
1XF0000	FCP ATX	354 3600 0,25 kW	T	4	0,25	0,80	66/F	-	71
1XV0000	FCP-V ATX								

LIVELLI SONORI | SOUND LEVELS dB(A)

Hz		63	125	250	500	1000	2000	4000	8000	TOT
FCP 354	LwA	46	70	72	75	76	73	72	66	81
FCP-V 354	LwA	43	71	73	76	74	71	70	65	81

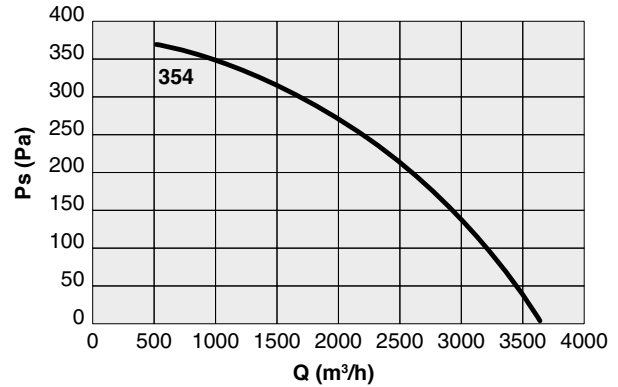

FCP - FCP-V ATEX D 400

Code	Tipo Type	Modello Model	U	P	Pm (kW)	In (A)	IP/CL	IE3	Mot. (Gr)
1XF0010	FCP ATX	404 5400 0,55 kW	M	4	0,55	4,50	66/F	-	80
1XV0010	FCP-V ATX								
1XF0001	FCP ATX	404 5400 0,55 kW	T	4	0,55	1,50	66/F	-	80
1XV0001	FCP-V ATX								

LIVELLI SONORI | SOUND LEVELS dB(A)

Hz		63	125	250	500	1000	2000	4000	8000	TOT
FCP 404	LwA	48	74	77	79	79	74	76	66	85
FCP-V 404	LwA	46	74	76	77	77	74	76	66	84

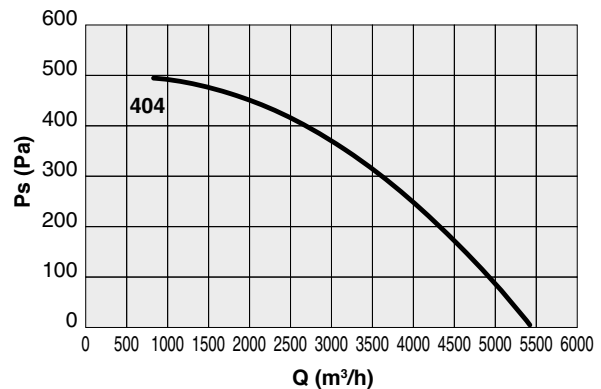

FCP - FCP-V ATEX D 450

Code	Tipo Type	Modello Model	U	P	Pm (kW)	In (A)	IP/CL	IE3	Mot. (Gr)
1XF0011	FCP ATX	454 7600 0,75 kW	M	4	0,75	2,20	66/F	✓	80
1XV0011	FCP-V ATX								
1XF0002	FCP ATX	454 7600 0,75 kW	T	4	0,75	2,00	66/F	✓	80
1XV0002	FCP-V ATX								

LIVELLI SONORI | SOUND LEVELS dB(A)

Hz		63	125	250	500	1000	2000	4000	8000	TOT
FCP 454	LwA	51	77	81	84	84	79	81	69	90
FCP-V 454	LwA	49	78	80	81	82	78	80	68	88

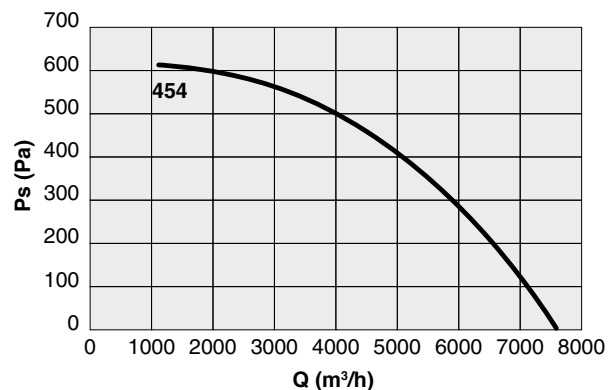

FCP - FCP-V ATEX 500

Code	Tipo Type	Modello Model	U	P	Pm (kW)	In (A)	IP/CL	IE3	Mot. (Gr)
1XF0003	FCP ATX	504 T 10000	T	4	1,5	3,30	66/F	✓	90
1XV0003	FCP-V ATX								

LIVELLI SONORI | SOUND LEVELS dB(A)

Hz		63	125	250	500	1000	2000	4000	8000	TOT
FCP 504	LwA	52	78	82	85	86	81	82	71	91
FCP-V 504	LwA	52	78	82	84	84	81	82	71	90

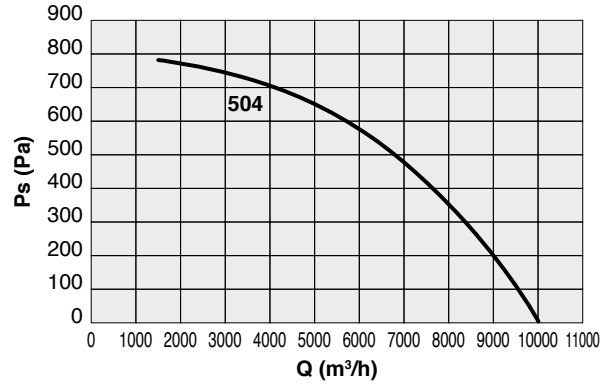

FCP - FCP-V ATEX 560

Code	Tipo Type	Modello Model	U	P	Pm (kW)	In (A)	IP/CL	IE3	Mot. (Gr)
1XF0012	FCP ATX	564 14150	T	4	3	6,30	66/F	✓	100
1XV0012	FCP-V ATX								
1XF0004	FCP ATX	566 9100	T	6	0,55	1,70	66/F	-	80
1XV0004	FCP-V ATX								

LIVELLI SONORI | SOUND LEVELS dB(A)

Hz		63	125	250	500	1000	2000	4000	8000	TOT
FCP 564	LwA	64	85	84	87	87	88	80	73	94
FCP-V 564	LwA	62	86	86	85	85	88	80	73	93
FCP 566	LwA	54	75	74	77	77	78	70	63	84
FCP-V 566	LwA	53	77	76	76	75	78	70	64	84

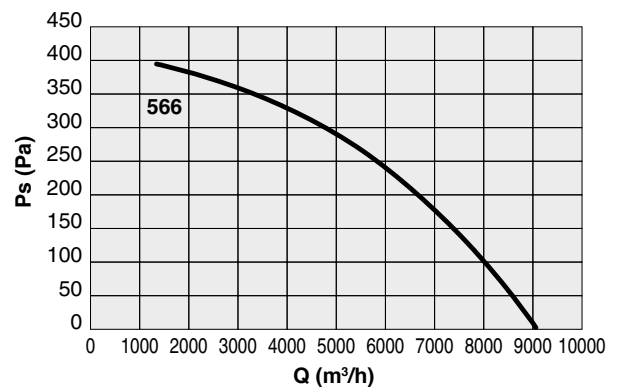
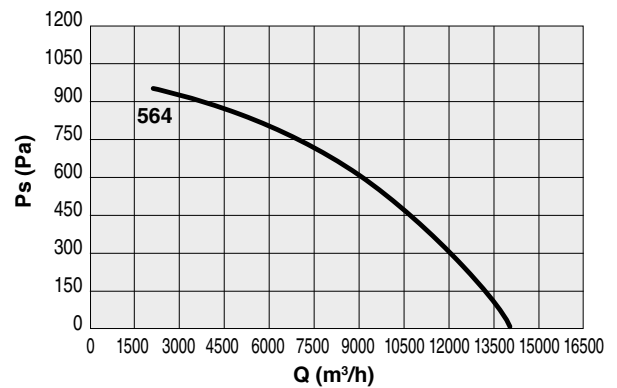

FCP - FCP-V ATEX 630

Code	Tipo Type	Modello Model	U	P	Pm (kW)	In (A)	IP/CL	IE3	Mot. (Gr)
1XF0013	FCP ATX	634 21200	T 4	5,5	10,40	66/F	✓	32	
1XV0013	FCP-V ATX								
1XF0005	FCP ATX	636 13700	T 6	1,10	2,70	66/F	✓	90	
1XV0005	FCP-V ATX								

LIVELLI SONORI | SOUND LEVELS dB(A)

Hz		63	125	250	500	1000	2000	4000	8000	TOT
FCP 634	LwA	67	88	90	93	90	91	88	76	98
FCP-V 634	LwA	66	89	89	89	88	89	90	84	97
FCP 636	LwA	57	78	80	83	80	81	78	66	88
FCP-V 636	LwA	57	80	79	80	78	79	80	75	87

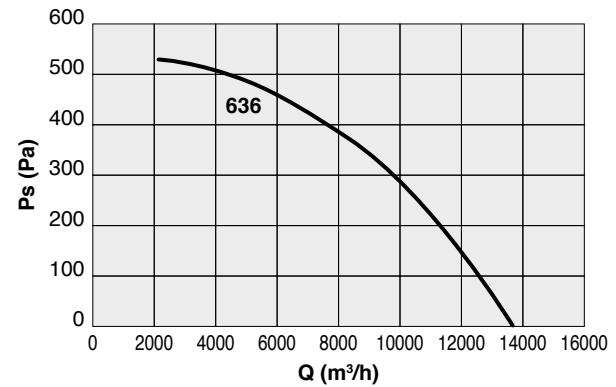
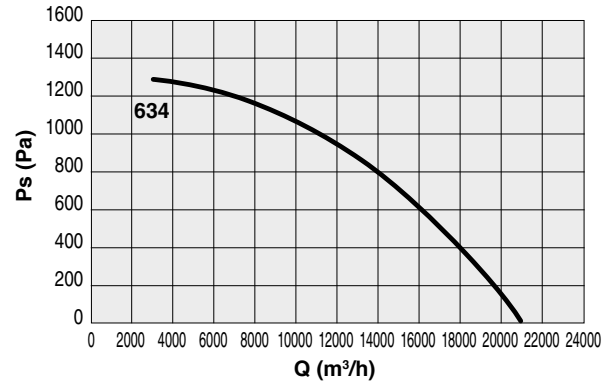

FCP - FCP-V ATEX 750

Code	Tipo Type	Modello Model	U	P	Pm (kW)	In (A)	IP/CL	IE3	Mot. (Gr)
1XF0014	FCP ATX	754 30400	T 4	9,2	17,60	66/F	✓	132	
1XV0014	FCP-V ATX								
1XF0006	FCP ATX	756 19500	T 6	2,2	5,40	66/F	✓	112	
1XV0006	FCP-V ATX								

LIVELLI SONORI | SOUND LEVELS dB(A)

Hz		63	125	250	500	1000	2000	4000	8000	TOT
FCP 754	LwA	77	92	94	97	97	99	86	79	104
FCP-V 754	LwA	73	91	93	94	94	97	85	78	101
FCP 756	LwA	67	82	84	87	87	89	76	69	94
FCP-V 756	LwA	64	82	83	85	84	87	75	69	92

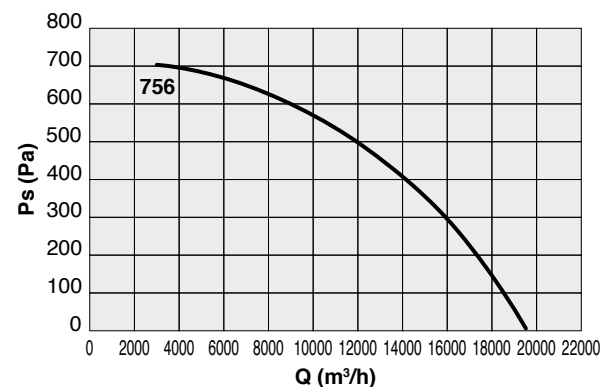
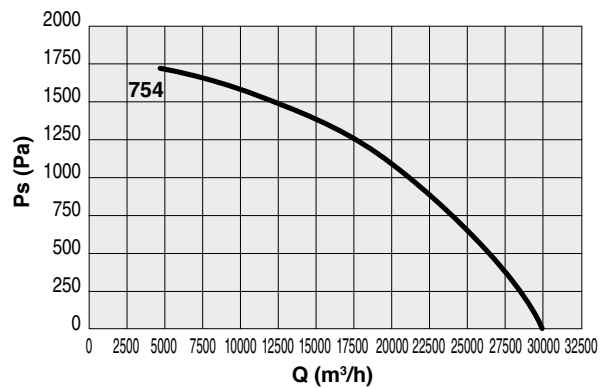

FCP - FCP-V ATEX 800

Code	Tipo Type	Modello Model	U	P	Pm (kW)	In (A)	IP/CL	IE3	Mot. (Gr)
1XF0007	FCP ATX	806 22500	T	6	3	6,75	66/F	✓	132
1XV0007	FCP-V ATX								

LIVELLI SONORI | SOUND LEVELS dB(A)

Hz		63	125	250	500	1000	2000	4000	8000	TOT
FCP 806	LwA	68	83	85	88	88	90	77	70	95
FCP-V 806	LwA	72	87	89	92	92	94	81	74	99

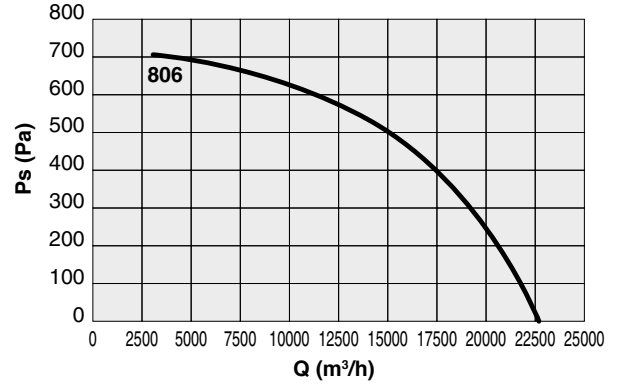

FCP - FCP-V ATEX 900

Code	Tipo Type	Modello Model	U	P	Pm (kW)	In (A)	IP/CL	IE3	Mot. (Gr)
1XF0008	FCP ATX	906 30000	T	6	5,5	11,50	66/F	✓	132
1XV0008	FCP-V ATX								

LIVELLI SONORI | SOUND LEVELS dB(A)

Hz		63	125	250	500	1000	2000	4000	8000	TOT
FCP 906	LwA	70	85	90	93	90	92	84	72	98
FCP-V 906	LwA	70	85	90	93	90	92	84	72	98

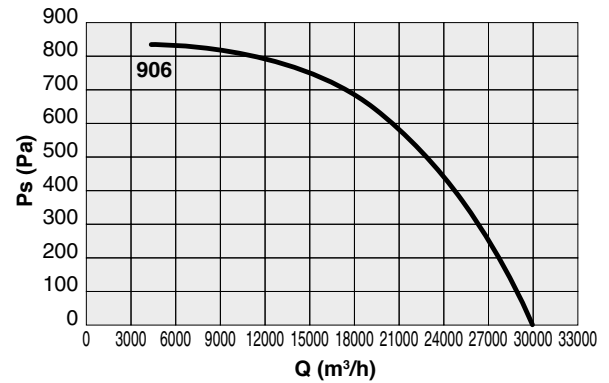

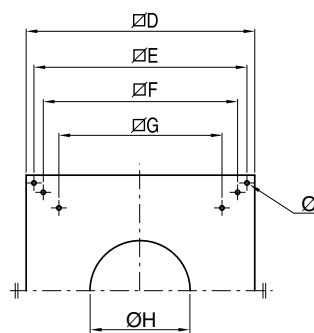
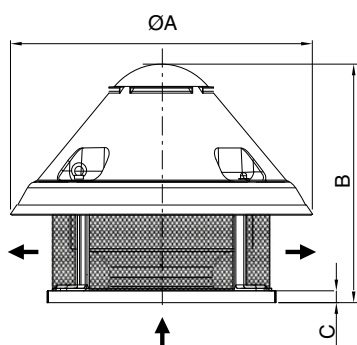

FCP ATEX

TIPO TYPE	$\varnothing A$	B	C	$\varnothing D$	$\varnothing E$	$\varnothing F$	$\varnothing G$	$\varnothing H$	$\varnothing I$	Kg
FCP ATX 350	755	630	38	500	450	-	370	237	12	30
FCP ATX 400	910	670	38	650	600	521	471	269	12	45
FCP ATX 450	910	700	38	650	600	521	471	301	12	50
FCP ATX 500	1000	790	38	760	710	630	550	331	14	80
FCP ATX 560	1000	830	38	760	710	630	550	370	14	70 (4p : 90)
FCP ATX 634	1100	1025	38	930	870	775	665	418	14	120
FCP ATX 636	1100	930	38	930	870	775	665	418	14	120
FCP ATX 754	1100	1075	38	930	870	775	665	470	14	210
FCP ATX 756	1100	980	38	930	870	775	665	470	14	170
FCP ATX 800	1400	1150	38	1100	1030	895	785	470	14	220
FCP ATX 900	1400	1180	38	1100	1030	895	785	530	14	250

Pesi indicativi | Indicative weights

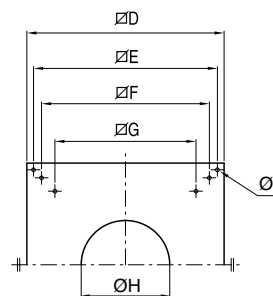
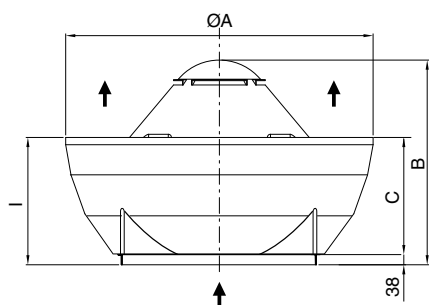

FCP-V ATEX

TIPO TYPE	$\varnothing A$	B	C	$\varnothing D$	$\varnothing E$	$\varnothing F$	$\varnothing G$	$\varnothing H$	$\varnothing I$	Kg
FCP-V ATX 350	800	630	300	500	450	-	370	237	12	34
FCP-V ATX 400	980	670	360	650	600	521	471	269	12	50
FCP-V ATX 450	980	700	360	650	600	521	471	301	12	55
FCP-V ATX 500	1200	790	450	760	710	630	550	331	14	86
FCP-V ATX 560	1200	830	450	760	710	630	550	370	14	76 (4p : 96)
FCP-V ATX 634	1400	1025	500	930	870	775	665	418	14	167
FCP-V ATX 636	1400	930	500	930	870	775	665	418	14	127
FCP-V ATX 754	1400	1075	500	930	870	775	665	470	14	217
FCP-V ATX 756	1400	980	500	930	870	775	665	470	14	172
FCP-V ATX 800	1600	1150	600	1100	1030	895	785	470	14	228
FCP-V ATX 900	1600	1180	600	1100	1030	895	785	530	14	258

Pesi indicativi | Indicative weights



GR | SILENZIATORI | SILENCERS

Silenziatori con setto centrale, riducono la rumorosità del torrino. Materiale fonoassorbente in lana minerale. Struttura portante in lamiera zincata. Attenzione: l'utilizzo del silenziatore abbinato alla serranda TS, l'utilizzo della versione con setto ribassato.

Silencers with central pod. They reduce the noise of the fan. Sound absorbing material: mineral wool. Frame in galvanized steel sheet. Attention: the use of a Silencer together with a TS shutter requires the use of the silencer with lowered pod.

Code (I)	Code (II)	Tipo Type	A	B	B ribassato lowered	C	D	E	F	G	ØH	Kg
1S10350	1S10457	GR 35	750	650	400	490	450	120	150	50	M8	37
1S10400	1S10454	GR 40	750	650	350	640	600	145	250	50	M8	42
1S10400	1S10454	GR 45	750	650	350	640	600	145	250	50	M8	42
1S10560	1S10458	GR 50	750	650	300	750	710	200	250	50	M10	42
1S10560	1S10458	GR 56	750	650	300	750	710	210	250	50	M10	50
1S10630	1S10691	GR 63	1000	800	500	920	870	210	400	50	M10	79
1S10630	1S10691	GR 75	1000	800	500	920	870	210	400	50	M10	79
1S10650	1S10851	GR 80	1000	800	500	1080	1030	980	400	50	M10	89
1S10850	1S10851	GR 90	1000	800	500	1080	1030	980	400	50	M10	89

(I) Versione standard | Standard version - (II) Versione con setto ribassato | Version with lowered pod

ATTENUAZIONE IN dB PER BANDA DI OTTAVA (Hz) OCTAVE (Hz) SPECTRUM OF NOISE ATTENUATION IN dB

Tipo Type	63	125	250	500	1000	2000	4000	8000
GR 35	3	5	9	11	19	20	18	14
GR 40	3	4	8	9	18	15	10	6
GR 45	3	4	8	9	18	15	10	6
GR 50	4	5	11	15	16	12	9	5
GR 56	4	5	11	15	16	12	9	5
GR 63	3	4	5	8	14	9	7	3
GR 75	3	4	5	8	14	9	7	3
GR 80	3	4	5	8	14	9	7	3
GR 90	3	4	5	8	14	9	7	3

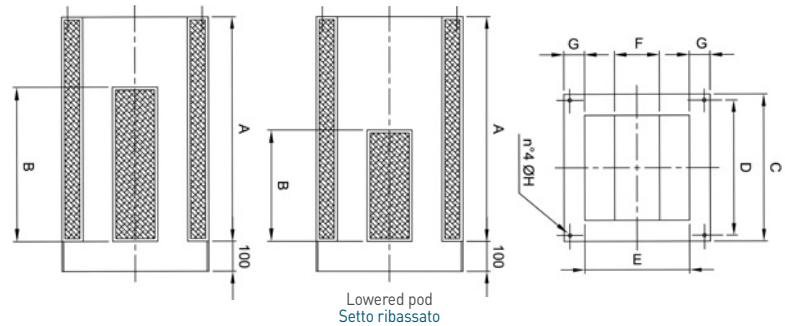

TS | SERRANDE A GRAVITÀ | GRAVITY SHUTTER

Evitano inutili dispersioni di calore e richiedono un'irrelevante perdita di carico. Le alette della serranda si aprono con la depressione dell'aria generata dal ventilatore in moto e si chiudono per gravità al suo spegnimento. La struttura è realizzata in lamiera zincata. Nel caso di utilizzo con silenziatore, utilizzare la versione di silenziatore con setto ribassato.

They avoid heat dispersion through the roof when this fan is not working with a negligible opening pressure. The shutter flaps are opened by the air depression produced by the fan when working, and they shut down by gravity after switching-off. The structured is made in galvanized steel sheet. In case of use with silencer, the version of silencer with lowered pod has to be used.

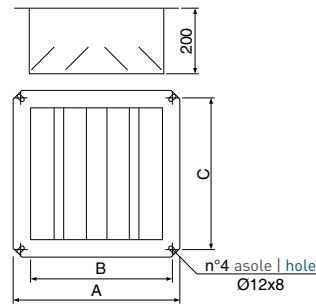

Code	Tipo Type	A	B	C	Kg
5TS1950	TS 35	425	325	370	5
5TS1951	TS 40/45	505	405	471	6
5TS1952	TS 50/56	610	510	550	7
5TS1953	TS 63/75	820	720	780	8
5TS1953	TS 80/90	820	720	780	8

CB | CONTROBASI A MURARE | COUNTER BASES TO BE WALLED UP

La controbase garantisce un efficace ancoraggio al cavedio, tramite la muratura delle quattro zanche appositamente realizzate. Manufatto realizzato in robusta lamiera con predisposto il fissaggio alla base del torrino.

The counter base ensures an effective anchorage to the concrete support, through the fixing of four metal strips suitably designed. It is made in solid steel with arrangement for fixing to the fan base.

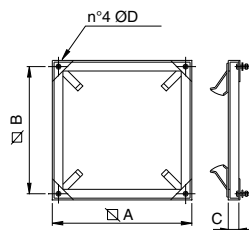

Code	Tipo Type	ØA	ØB	C	ØD	Kg
1CB3500	CB 35	490	450	30	M8X30	2,8
1CB4000	CB 40	630	600	30	M8X30	3,2
1CB4000	CB 45	630	600	30	M8X30	3,2
1CB5500	CB 50	740	710	30	M10X40	3,6
1CB5500	CB 56	740	710	30	M10X40	3,6
1CB6000	CB 63	900	870	30	M10X40	4,0
1CB6000	CB 75	900	870	30	M10X40	4,0
1CB8000	CB 80	1070	1030	30	M10X40	5,0
1CB8000	CB 90	1070	1030	30	M10X40	5,0



BA | BASE D'APPOGGIO PER TORRINI | SUPPORT BASE FOR ROOF FANS

DESCRIZIONE - Le basi d'appoggio BA e la riduzione RD sono adatte per l'installazione dei nostri torrini su coperture costruite in lastre ondulate, evitando dannosi ristagni d'acqua attorno al ventilatore e costose opere murarie o di carpenteria. La base d'appoggio BA è utilizzabile per torrini aventi basamento da 930x930. Con l'apposita riduzione RD è possibile utilizzare la base per basamenti di torrini fino ad un minimo di 500x500. La riduzione RD è un unico elemento dove con un semplice taglio si elimina la parte eccedente.

VERSIONI

- BA 10x177 (Cod. 5PL1008) La base è accoppiabile a lastre tipo "EURO" passo 177 mm, altezza 51 mm e pendenza falda pari al 10%.
- BA 3x177 (Cod. 5PL1015) La base è accoppiabile a lastre tipo "EURO" passo 177 mm, altezza 51 mm e raggio di curvatura lastra pari a 3 metri.
- BA 10x146 (Cod. 5PL1009) La base è accoppiabile a lastre tipo "INTERNAZIONALE" passo 146 mm, altezza 48 mm, pendenza falda pari al 10%.
- Riduzione RD (Cod. 5PL1010).

COSTRUZIONE - In resine poliestere rinforzato con fibra di vetro stratificato. La finitura è RAL 9002 (grigio chiaro). La superficie esterna è trattata per resistere nel tempo agli agenti atmosferici.

POSA IN OPERA - Una posa corretta prevede la sovrapposizione alla lastra di copertura a valle e una sottoesposizione a monte. Inoltre è da prevedere una sovrapposizione laterale di almeno un'onda e un quarto per lato.

DESCRIPTION - The support base BA and reduction RD are suitable for installation of roof fans on waved coverings, avoiding detrimental stagnation of water near to the fan and expensive carpentry works. The support base BA is suitable for roof fans having base 930mm X 930 mm or bigger. With the suitable reduction RD it is possible to use the base for roof fans from a minimum base dimension of 500X500. The reduction RD is a single element that can be easily cut to fit the exact fan dimension.

VERSION

- BA 10x177 (Cod. 5PL1008): suitable for "EURO" roof coverings pitch 177, height 51 mm and 10% slope.
- BA 3x177 (Cod. 5PL1015): suitable for "EURO" roof coverings pitch 177 mm, height 51 mm and radius of curvature of the sheet of 3 meters.
- BA 10x146 (Cod. 5PL1009): suitable for "INTERNATIONAL" roof coverings pitch 146 mm, height 48 mm, and 10% slope.
- Reduction RD (Cod. 5PL1010).

CONSTRUCTION - In polyester resins strengthen with stratified fibre glass. The finishing is RAL 9002(light grey). The external surface is treated against the action of atmospheric agent.

INSTALLATION - A correct fitting foresees the overlap to the covering slab downstream and the underexposure upstream. Furthermore it must be foreseen a side overlap of at least one and quarter wave for each side.

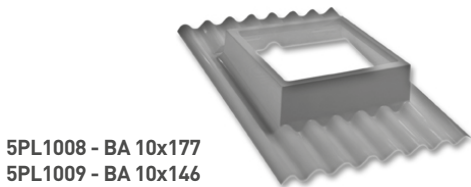

5PL1008 - BA 10x177
5PL1009 - BA 10x146

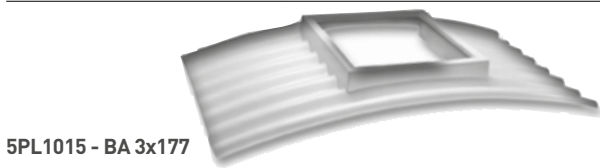
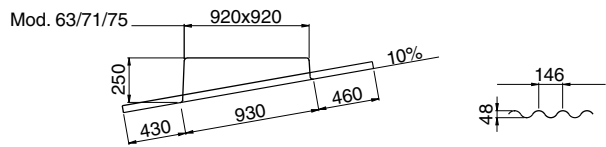

5PL1015 - BA 3x177

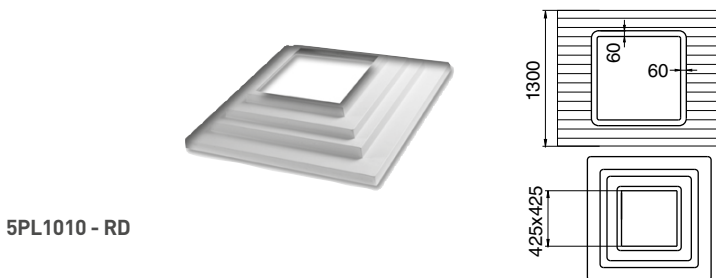
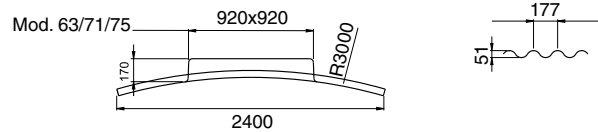

5PL1010 - RD

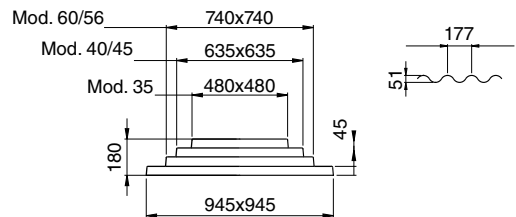

Dimensioni in mm | Dimensions in mm

PB | BASE D'APPOGGIO/ RIDUZIONE SILENZIATA
PURLING BOX

La base d'appoggio/riduzione silenziata (PB), o purling box, è adatta per l'installazione dei nostri torrini su coperture piatte ed è comprensiva di isolamento acustico dal lato aspirazione del torrino. Struttura in lamiera zincata. Rivestimento fonoassorbente bugnato all'interno.

The silenced support base (PB) purling box is suitable for the installation of roof fans on flat covering. This support contains an acoustic isolation to reduce the noise of the fans at the inlet side support. Base frame in galvanized steel sheet. Internally lined with acoustic material.

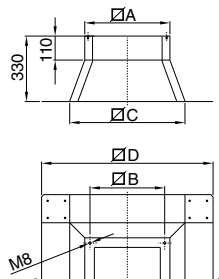

CCr | RETE PROTEZIONE BOCCA ASPIRANTE
INLET PROTECTION GUARD

Salvaguardano dal contatto accidentale con le parti in movimento del ventilatore. Realizzate in filo d'acciaio, a norma UNI 12499 e protette contro gli agenti atmosferici.

They prevent from casual contact with moving parts of the fan. Manufactured in steel rod according to UNI 12499 standard and protected against atmospheric agents.

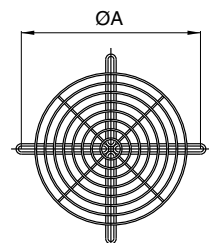

Code	Tipo Type	ØA	ØB	ØC	ØD
5PB3500	35	480	450	620	880
5PB4000	40/45	630	600	770	1030
5PB5000	50/56	740	710	880	1140
5PB6300	63/75	910	870	1050	1310
5PB8000	80/90	1070	1030	1210	1470

Dimensioni in mm | Dimensions in mm

Code	Tipo Type	Per modello For model	ØA	Kg
5RE9051	CCr 50	FCP - FCP-V ATEX 35	560	1,3
5RE9064	CCr 63	FCP - FCP-V ATEX 40-45	620	1,9
5RE9083	CCr 80	FCP - FCP-V ATEX 50-56	690	3,0
5RE9093	CCr 90	FCP - FCP-V ATEX 63-75	970	3,4

Dimensioni in mm | Dimensions in mm