



AL ATEX

Aspiratori centrifughi pale avanti Forward curved blade centrifugal fans



Zone 1 II2G Ex h IIB T4 Gb
GAS

Certificato | Certificate

IMQ 10 ATEX 017 X

NORME | NORMS

EN 14986:2017
EN 1127-1
EN ISO 80079-36
EN ISO 80079-37

Attestato di Esame del Tipo Type Examination Statement



IMQ 10 ATEX 017 X

A RICHIESTA UPON REQUEST

- Versioni a 60 Hz
- Classi di temperatura T5 e T6
- Versions at 60 Hz
- Temperature classes T5 and T6

VERSIONI | VERSIONS



AL ATEX
Zone 21
II2D Ex h IIB T135°C Db
DUST



AL ATEX
Zone 1
II2G Ex IIB+H2 T4 Gb
HYDROGEN

DESCRIZIONE

Gli aspiratori centrifughi della serie AL ATEX sono costruiti e certificati in conformità alla Direttiva ATEX 2014/34/UE.

Sono specificatamente progettati per essere utilizzati in zona 1, ossia in aree o ambienti dove sia necessario garantire un elevato fattore di sicurezza contro le esplosioni dovute alla presenza di gas, vapori, nebbie (II2G). Il loro impiego è previsto per convogliare aria pulita con temperature comprese in un range da -20°C a +60°C (su richiesta, da -40°C a +60°C). Trovano il loro impiego in tutte quelle applicazioni industriali dove siano richiesti piccoli volumi d'aria con alte pressioni. La cassa è facilmente orientabile, anche in sito, ogni 45°, esclusi gli orientamenti 180° e 225° che richiedono una costruzione speciale.

COSTRUZIONE

- Cassa a spirale realizzata in lamiera d'acciaio. Protetta contro gli agenti atmosferici con vernici a polveri epossipoliestiriche.
- Girante a semplice aspirazione, con pale curve in avanti (sirocco), a spessore costante, realizzata in lamiera zincata dal tipo 200 al 315 e in lamiera d'acciaio con pale saldate e verniciate dal tipo 355 al 450.
- Boccaglio in lamiera verniciata.
- Esecuzione 4 (accoppiamento diretto con girante a sbalzo e motore sostenuto da supporto).
- Orientamento standard LG 270°.

MOTORE

Motore antideflagrante asincrono trifase o monofase a norme internazionali IEC 60034, IEC 60072, ATEX 2014/34/UE, EMC 2014/30/UE, LVD 2014/35/UE, marcato CE, IP55 secondo la EN ISO 20653, classe F. Idoneo ad un servizio continuo (S1). Specificamente progettato per installazione in ambienti classificati come zona ATEX 1 II2G (GAS) IIB, apparecchiature protette mediante custodie a prova d'esplosione "db" in accordo allo standard CEI EN IEC 60079-0, CEI EN 60079-1. Motore dotato di sistema di protezione da sovratemperatura con termistori tipo PTC conformi alle norme DIN 44081, DIN 44082, IEC 60034-11-2 e idoneo alla regolazione di velocità a mezzo di regolatore tipo inverter (per la versione trifase).

ACCESSORI

- Rete di protezione per bocca aspirante e premente realizzata a norma UNI 12499 e protetta contro gli agenti atmosferici.
- Raccordo aspirante, realizzato in lamiera protetta dagli agenti atmosferici.

DESCRIPTION

The centrifugal fans of the AL ATEX series are built and certified in compliance with ATEX Directive 2014/34/UE.

They are specifically designed to be used in zone 1, i.e. in areas or environments where it is necessary to guarantee a high safety factor against explosions due to the presence of gases, vapors, mists (II2G). They are suitable to convey clean air with a temperature included in a range from -20°C to +60°C (on request, from -40°C to +60°C).

They are ideal for all the industrial applications where small air volumes and high pressures are required. The casing is easily adjustable, also on site, to the required discharge angle every 45°, excluding orientations 180° and 225° which require a special construction.

CONSTRUCTION

- Volute casing in folded steel sheet, protected against atmospheric agent by epoxy paint.
- Single inlet, single width, forward curved impeller (sirocco type), manufactured in galvanized steel sheet from type 200 to 315 and in steel sheet with welded blades epoxy painted from type 355 to 450.
- Inlet in steel sheet with epoxy finish.
- Execution 4 (with impeller directly coupled to motor).
- Standard orientation LG 270°.

MOTOR

Explosion-proof asynchronous three-phase or single-phase motor compliant with international standards IEC 60034, IEC 60072, ATEX 2014/34/UE, EMC 2014/30/UE, LVD 2014/35/UE, CE marked, IP55 according to EN ISO 20653, class F. Suitable for continuous duty (S1). Specifically designed for installation in environments classified as ATEX zone 1 II2G (GAS) IIB, equipment protected by flame-proof enclosures "db" according to CEI EN IEC 60079-0, CEI EN 60079-1 standard. The motor includes an overtemperature protection system equipped with PTC thermistors in accordance with DIN 44081, DIN 44082, IEC 60034-11-2 and suitable for speed regulation by inverter-type controller (for three-phase version).

ACCESSORIES

- Inlet and outlet protection guard manufactured according to UNI 12499 norm and protected against the atmospheric agents.
- Round inlet cone, in steel sheet epoxy coated.

PRESTAZIONI | PERFORMANCE

AL ATEX 

Le prestazioni aerauliche sono rilevate in conformità alla norma EN ISO 5801/AMCA 210 con densità dell'aria standard avente peso specifico 1,2 Kg/m³. Il livello di potenza sonora è ottenuto secondo la norma AMCA 300-08 in camera riverberante. Installazione D. Le tolleranze sono conformi alla ISO 13348 e alla DIN 24166. Alimentazione 230V/1Ph/50Hz o 400V/3Ph/50Hz.

Air performances are measured according to EN ISO 5801 / AMCA 210 standard with air density with 1.2 kg/m³ specific weight. The sound power level is obtained according to AMCA 300-08 in reverberating room. Installation D. Tolerances comply with ISO 13348 and DIN 24166. Power supply 230V/1Ph/50Hz or 400V/3Ph/50Hz.

U - M/T Alimentazione elettrica Monofase/Tri fase Power supply Single/Three-phase	P N° di poli motore N° of motor poles (RPM: 2p-3000 4p-1500 6p-1000 8p-750)	Pm (kW) Potenza nominale motore Motor power rating	In (A) Corrente nominale a pieno carico Full load current	IP/CL Grado di protezione motore/Classe di isolamento Motor protection grade/Insulation class	Mot. (Gr) Grandezza motore Motor size	Lp/Lw (dBA) Livello di pressione e potenza sonora Sound pressure and volume levels	Ps (Pa) Pressione statica Static pressure	Q (m³/h) Portata volumetrica Airflow volume
--	--	---	--	--	--	---	--	--

AL ATEX 200

Code	Tipo Type	Modello Model	U	P	Pm (kW)	In (A)	IP/CL	IE3	Mot (GR.)
1XA2026	AL ATX	200/2	T	2	1,10	2,40	55/F	-	80
1XA2027		200/4	T	4	0,25	0,80	55/F	-	71

LIMITI D'IMPIEGO | OPERATIONAL LIMIT

Tipo Type	Modello Model	Q max (m³/h)	Pt min (Pa)	C max (m/s)	S (m²)	Pd² (Kg/m²)
AL ATX	200/2	1700	1050	19,43	0,0243	0,02
	200/4	1550	211	17,72	0,0243	0,02

LIVELLI SONORI | SOUND LEVELS dB(A)

Hz		62,5	125	250	500	1000	2000	4000	8000	TOT
200/2	LwA	67	79	85	88	90	89	78	68	95
	Lp	56	68	74	77	79	78	67	57	84
200/4	LwA	51	63	68	72	77	70	62	52	79
	Lp	40	52	57	61	66	59	51	41	68

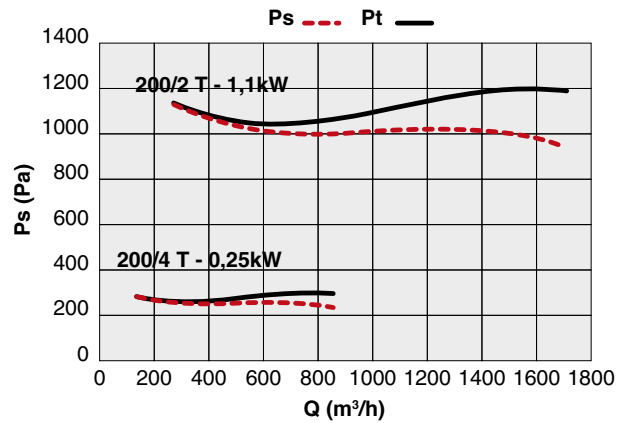

AL ATEX 225

Code	Tipo Type	Modello Model	U	P	Pm (kW)	In (A)	IP/CL	IE3	Mot (GR.)
1XA2225	AL ATX	225/2	T	2	2,20	4,40	55/F	-	90
1XA2226		225/4	T	4	0,55	1,50	55/F	-	80

LIMITI D'IMPIEGO | OPERATIONAL LIMIT

Tipo Type	Modello Model	Q max (m³/h)	Pt min (Pa)	C max (m/s)	S (m²)	Pd² (Kg/m²)
AL ATX	225/2	2720	1382	24,37	0,031	0,032
	225/4	1950	329	17,47	0,031	0,032

LIVELLI SONORI | SOUND LEVELS dB(A)

Hz		62,5	125	250	500	1000	2000	4000	8000	TOT
225/2	LwA	67	79	85	88	90	89	78	68	95
	Lp	56	68	74	77	79	78	67	57	84
225/4	LwA	51	63	69	72	77	70	62	52	79
	Lp	40	52	58	61	66	58	51	41	68

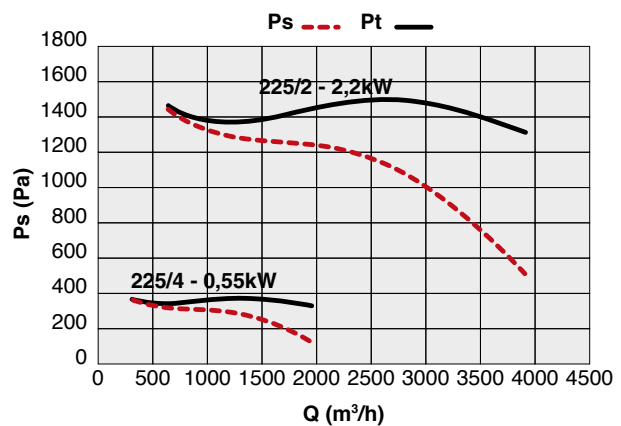

PRESTAZIONI | PERFORMANCE

AL ATEX 

U - M/T

Alimentazione elettrica
Monofase/Trifase
Power supply
Single/Three-phase

P

N° di poli motore
N° of motor poles
(RPM: 2p=3000 4p=1500
6p=1000 8p=750)

Pm (kW)

Potenza
nominale motore
Motor power rating

In (A)

Corrente nominale
a pieno carico
Full load current

IP/CL

Grado di protezione
motore/Classe di isolamento
Motor protection
grade/Insulation class

Mot. (Gr)

Grandezza
motore
Motor size

Lp/Lw (dBA)

Livello di pressione
e potenza sonora
Sound pressure
and volume levels

Ps (Pa)

Pressione
statica
Static pressure

Q (m³/h)

Portata
volumetrica
Airflow
volume

AL ATEX 250

Code	Tipo Type	Modello Model	U	P	Pm (kW)	In (A)	IP/CL	IE3	Mot (GR.)
1XA2539		250/2	T	2	3,00	5,50	55/F	✓	100
1XA2540	AL ATX	250/4	T	4	0,75	2,00	55/F	✓	80
1XA2541		250/6	T	6	0,37	1,25	55/F	-	80

LIMITI D'IMPIEGO | OPERATIONAL LIMIT

Tipo Type	Modello Model	Q max (m³/h)	Pt min (Pa)	C max (m/s)	S (m²)	Pd² (Kg/m²)
	250/2	2920	472	21,10	0,0385	0,072
AL ATX	250/4	2450	371	17,68	0,0385	0,072
	250/6	1930	124	13,925	0,0385	0,072

LIVELLI SONORI | SOUND LEVELS dB(A)

Hz		62,5	125	250	500	1000	2000	4000	8000	TOT
250/4	LwA	53	65	71	74	79	72	64	54	81
	Lp	42	54	60	63	68	61	53	43	70
250/6	LwA	44	56	61	68	67	63	55	45	71
	Lp	33	45	50	57	56	52	44	34	61

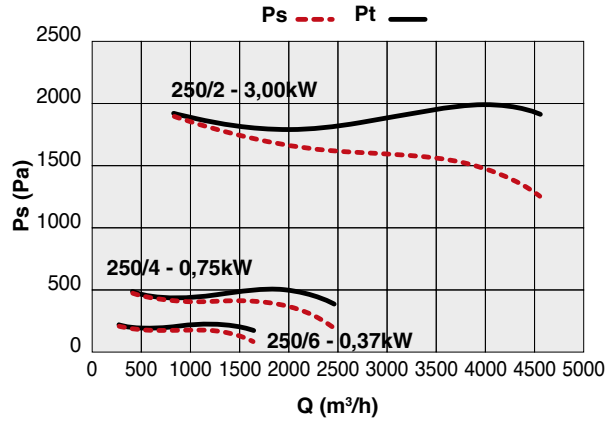

AL ATEX 280

Code	Tipo Type	Modello Model	U	P	Pm (kW)	In (A)	IP/CL	IE3	Mot (GR.)
1XA2839		280/4 A	T	4	1,50	3,30	55/F	✓	90
1XA2840	AL ATX	280/4 B	T	4	1,10	2,70	55/F	✓	90
1XA2841		280/6	T	6	0,75	2,70	55/F	✓	90

LIMITI D'IMPIEGO | OPERATIONAL LIMIT

Tipo Type	Modello Model	Q max (m³/h)	Pt min (Pa)	C max (m/s)	S (m²)	Pd² (Kg/m²)
	280/4	3540	452	19,39	0,0507	0,12
AL ATX	280/6	2820	174	15,45	0,0507	0,12

LIVELLI SONORI | SOUND LEVELS dB(A)

Hz		62,5	125	250	500	1000	2000	4000	8000	TOT
280/4	LwA	53	65	71	74	79	72	64	54	81
	Lp	42	54	60	63	68	61	53	43	70
280/6	LwA	47	59	65	71	70	66	58	48	75
	Lp	36	48	54	60	59	55	47	37	64

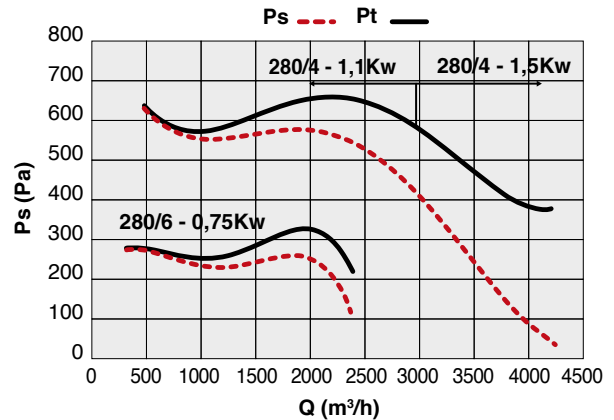

PRESTAZIONI | PERFORMANCE

AL ATEX 

U - M/T

Alimentazione elettrica
Monofase/Trifase
Power supply
Single/Three-phase

P

N° di poli motore
N° of motor poles
(RPM: 2p=3000 4p=1500
6p=1000 8p=750)

Pm (kW)

Potenza
nominale motore
Motor power rating

In (A)

Corrente nominale
a pieno carico
Full load current

IP/CL

Grado di protezione
motore/Classe di isolamento
Motor protection
grade/Insulation class

Mot. (Gr)

Grandezza
motore
Motor size

Lp/Lw (dBA)

Livello di pressione
e potenza sonora
Sound pressure
and volume levels

Ps (Pa)

Pressione
statica
Static pressure

Q (m³/h)

Portata
volumetrica
Airflow
volume

AL ATEX 315

Code	Tipo Type	Modello Model	U	P	Pm (kW)	In (A)	IP/CL	IE3	Mot (GR.)
1XA3136		315/4 A	T	4	3,00	6,50	55/F	✓	100
1XA3137	AL ATEX	315/4 B	T	4	2,20	5,50	55/F	✓	100
1XA3138		315/6	T	6	1,10	2,70	55/F	✓	90

LIMITI D'IMPIEGO | OPERATIONAL LIMIT

Tipo Type	Modello Model	Q max (m³/h)	Pt min (Pa)	C max (m/s)	S (m²)	Pd² (Kgm²)
AL ATEX	315/4	5760	482	24,81	0,0645	0,20
	315/6	4200	195	18,09	0,0645	0,20

LIVELLI SONORI | SOUND LEVELS dB(A)

Hz		62,5	125	250	500	1000	2000	4000	8000	TOT
315/4	LwA	60	72	78	81	86	79	71	61	88
	Lp	49	61	67	70	75	68	60	50	77
315/6	LwA	50	62	68	74	73	69	61	51	78
	Lp	39	51	57	63	62	58	50	40	67

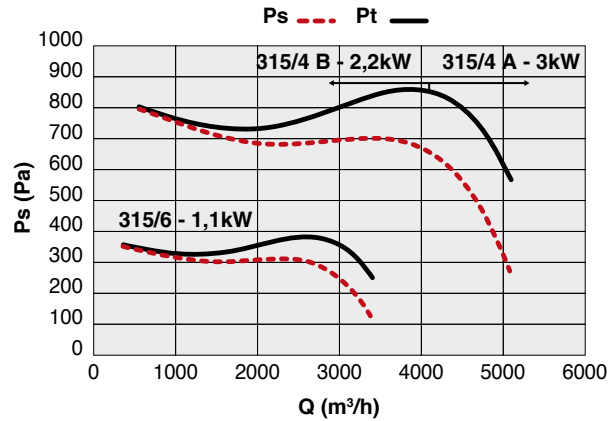

AL ATEX 355

Code	Tipo Type	Modello Model	U	P	Pm (kW)	In (A)	IP/CL	IE3	Mot (GR.)
1XA3515		355/4 A	T	4	4,00	8,80	55/F	✓	112
1XA3516	AL ATEX	355/4 B	T	4	3,00	6,50	55/F	✓	100
1XA3517		355/6	T	6	1,50	3,80	55/F	✓	100
1XA3518		355/8	T	8	0,75	2,60	55/F	✓	100

LIMITI D'IMPIEGO | OPERATIONAL LIMIT

Tipo Type	Modello Model	Q max (m³/h)	Pt min (Pa)	C max (m/s)	S (m²)	Pd² (Kgm²)
AL ATEX	355/4 - A	7660	425	24,69	0,08616	0,71
	355/6	5030	197	16,22	0,08616	0,71
	355/4 - B	6715	500	21,65	0,08616	0,71
	355/8	3680	90	11,86	0,08616	0,71

LIVELLI SONORI | SOUND LEVELS dB(A)

Hz		62,5	125	250	500	1000	2000	4000	8000	TOT
355/4	LwA	66	78	83	87	92	85	77	67	94
	Lp	55	67	72	76	81	74	66	56	83
355/6	LwA	56	68	74	80	79	75	67	57	84
	Lp	45	57	63	69	68	64	56	46	73

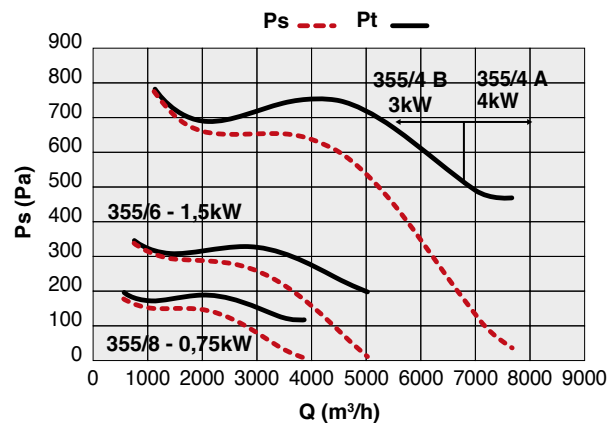

PRESTAZIONI | PERFORMANCE

AL ATEX 

U - M/T

Alimentazione elettrica
Monofase/Trifase
Power supply
Single/Three-phase

P

N° di poli motore
N° of motor poles
(RPM: 2p=3000 4p=1500
6p=1000 8p=750)

Pm (kW)

Potenza
nominale motore
Motor power rating

In (A)

Corrente nominale
a pieno carico
Full load current

IP/CL

Grado di protezione
motore/Classe di isolamento
Motor protection
grade/Insulation class

Mot. (Gr)

Grandezza
motore
Motor size

Lp/Lw (dB(A))

Livello di pressione
e potenza sonora
Sound pressure
and volume levels

Ps (Pa)

Pressione
statica
Static pressure

Q (m³/h)

Portata
volumetrica
Airflow
volume

AL ATEX 400

Code	Tipo Type	Modello Model	U	P	Pm (kW)	In (A)	IP/CL	IE3	Mot (GR.)
1XA4022	AL ATX	400/4 A	T	4	7,50	14,40	55/F		132
1XA4023		400/4 B	T	4	5,50	11,94	55/F		132
1XA4024		400/6	T	6	2,20	5,40	55/F		112
1XA4025		400/8	T	8	1,10	3,00	55/F		100

LIMITI D'IMPIEGO | OPERATIONAL LIMIT

Tipo Type	Modello Model	Q max (m³/h)	Pt min (Pa)	C max (m/s)	S (m²)	Pd² (Kg/m²)
AL ATX	400/4 A	9300	250	24,84	0,104	1,40
	400/4 B	5850	1115	15,63	0,104	1,40
	400/6	6290	325	16,80	0,104	1,40
	400/8	4720	185	12,61	0,104	1,40

LIVELLI SONORI | SOUND LEVELS dB(A)

Hz		62,5	125	250	500	1000	2000	4000	8000	TOT
400/4 A	LwA	68	80	85	89	94	87	79	69	96
	Lp	54	66	71	75	80	73	65	55	82
400/4 B	LwA	67	79	84	88	93	86	78	68	95
	Lp	53	65	70	74	79	72	64	54	81
400/6	LwA	58	70	76	82	81	77	69	59	86
	Lp	44	56	62	68	67	63	55	45	72
400/8	LwA	51	63	72	72	74	70	62	52	78
	Lp	37	49	58	58	60	56	48	38	64

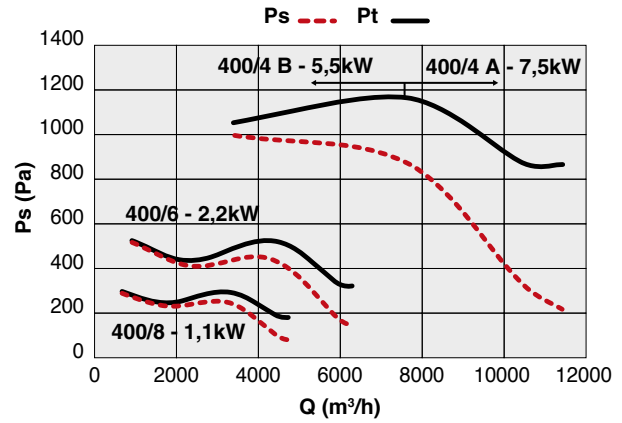

AL ATEX 450

Code	Tipo Type	Modello Model	U	P	Pm (kW)	In (A)	IP/CL	IE3	Mot (GR.)
1XA4507	AL ATX	450/4	T	4	9,00	17,50	55/F	✓	132
1XA4508		450/6	T	6	4,00	8,64	55/F	✓	132
1XA4509		450/8	T	8	2,20	5,20	55/F	✓	132

LIMITI D'IMPIEGO | OPERATIONAL LIMIT

Tipo Type	Modello Model	Q max (m³/h)	Pt min (Pa)	C max (m/s)	S (m²)	Pd² (Kg/m²)
AL ATX	450/4	10770	1200	23,01	0,13	2,92
	450/6	7140	355	15,26	0,13	2,92
	450/8	5450	200	11,63	0,13	2,92

LIVELLI SONORI | SOUND LEVELS dB(A)

Hz		62,5	125	250	500	1000	2000	4000	8000	TOT
450/4	LwA	71	83	89	92	97	90	82	71	100
	Lp	57	69	75	78	83	76	68	58	86
450/6	LwA	62	74	80	86	85	81	73	63	90
	Lp	48	60	66	72	71	67	59	49	76
450/8	LwA	55	67	76	76	78	74	66	56	82
	Lp	41	53	62	62	64	60	52	42	68

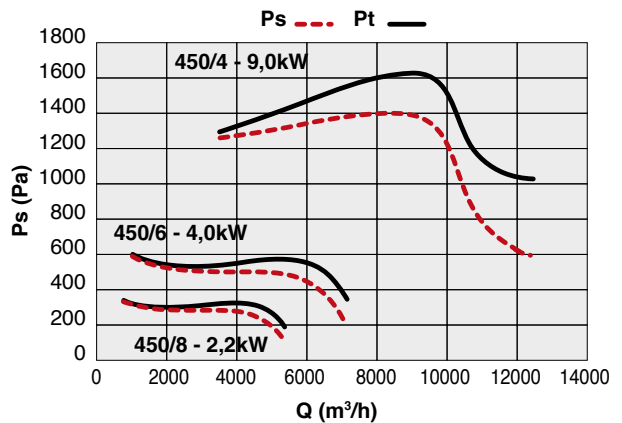

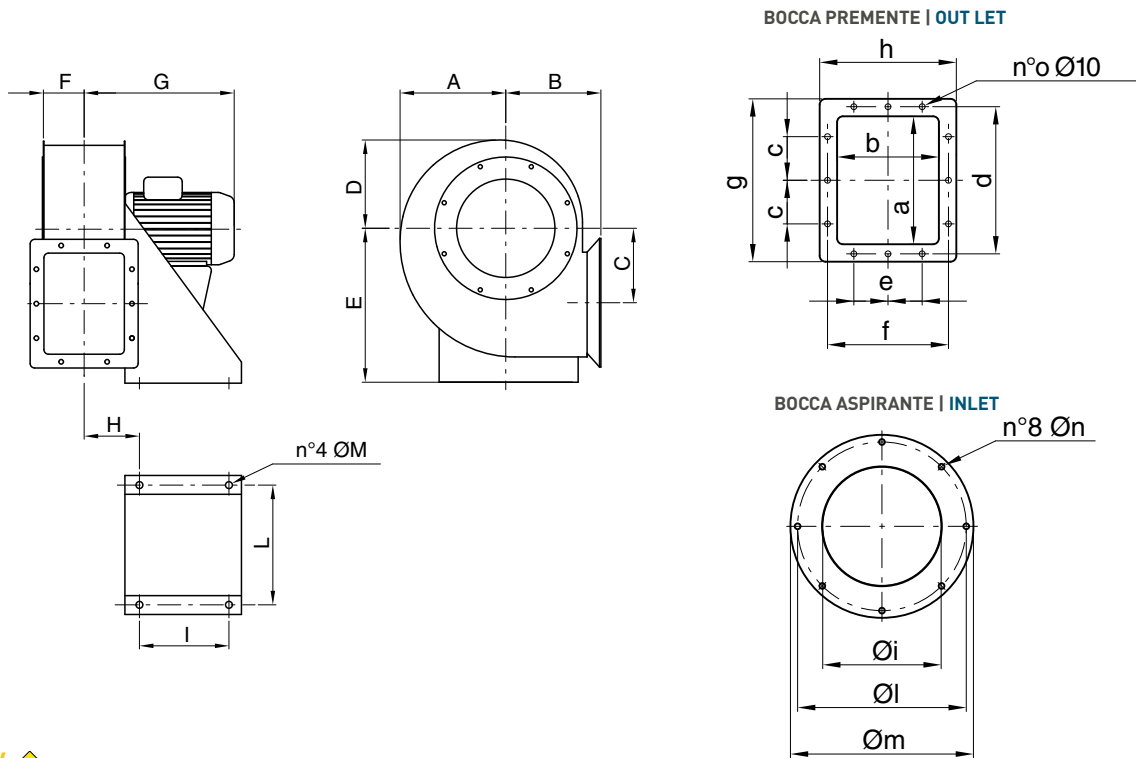



AL ATEX 

TIPO TYPE	A	B	C	D	E	F	G	H	I	L	ØM	a	b	c	d	e	f	g	h	Øi	Øl	Øm	Øn	n°	Kg
AL ATX 200	183	176	120	156	280	70	355	103	140	218	12	180	135	75	213	100	168	240	195	164	235	255	M6	10	20
AL ATX 225	210	193	141	175	310	78	345	111	140	218	12	200	155	75	233	100	188	260	215	189	260	280	M6	10	32
AL ATX 250	231	210	162	193	335	90	375	120	205	270	12	220	175	75	253	100	208	280	235	210	290	310	M6	10	39
AL ATX 280	257	230	170	216	365	98	410	132	205	270	12	260	195	100	293	125	228	320	255	240	310	340	M8	10	40
AL ATX 315	288	252	192	245	405	109	570	140	205	319	12	300	215	100	333	150	248	360	275	275	335	375	M8	10	55
AL ATX 355	321	275	212	270	445	121	480	153	245	354	15	340	240	125	373	100	273	400	300	302	395	425	M8	12	73
AL ATX 400	358	303	235	301	505	136	650	168	245	370	15	388	273	125	425	100	310	465	350	352	445	465	M8	12	123
AL ATX 450	406	337	267	337	560	151	695	183	340	439	15	430	300	150	470	100	340	510	380	402	490	520	M8	12	146

Pesi indicativi | Indicative weights

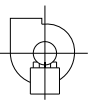
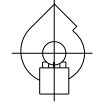
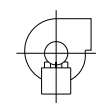
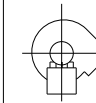
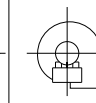
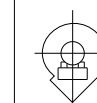
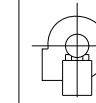
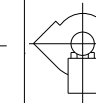
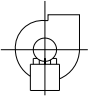
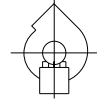
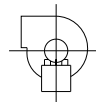
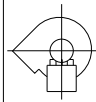
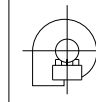
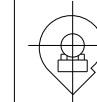
ORIENTAMENTI | DISCHARGE ANGLES

Rotazione Rotation RD								
Forma Form	0°	45°	90°	135°	180°	225°	270°	315°
Rotazione Rotation LG								

N.B.: Orientamento standard LG 270°. | Standard discharge angles LG 270°.

INSTALLAZIONE

I ventilatori centrifughi con girante a pale curve in avanti devono sempre funzionare collegati a tubazioni o prevedere sistemi, che con la loro resistenza (ad esempio serrande di taratura), ne limitino la portata in modo tale che i valori di corrente assorbita rientrino nei valori ammissibili riportati sulla targa del motore elettrico.

INSTALLATION

The centrifugal fans with forward curved impellers must always be installed to ducted systems, eventually with the use of additional resistance (for example setting shutters), that can limit the air flow in such a way that the absorbed current is within the acceptable values stated on the motor rating label.



RACCORDO ASPIRANTE | ROUND INLET ADAPTER

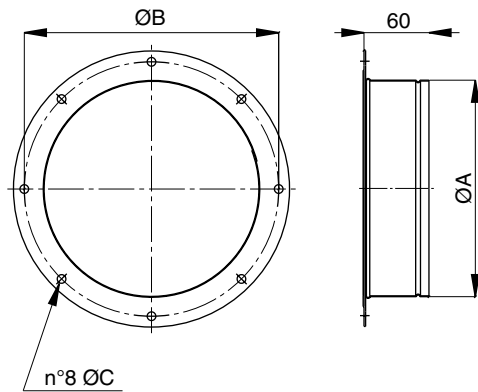

Code	Tipo Type	A	B	C	Kg
5B02100	200	200	235	8	0,5
5B02202	225	200	260	8	0,6
5B02601	250	250	290	8	0,7
5B02801	280	250	310	9,5	0,8
5B08319	315	315	355	9,5	1
5B08361	355	350	395	9,5	1
5B08403	400	400	445	9,5	1,2
5B08600	450	450	490	9,5	1,3

Dimensioni in mm. Pesi indicativi | Indicative weights. Dimensions in mm

RETE BOCCA PREMENTE | OUTLET GUARD

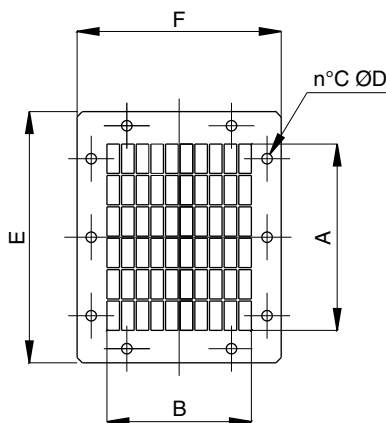

Code	Tipo Type	A	B	C	D	E	F	Kg
5RE7500	200	169	136	10	10	240	195	0,7
5RE7505	225	198	164	10	10	260	215	0,8
5RE7510	250	227	178	10	10	280	235	1,0
5RE7515	280	256	192	10	10	320	255	1,2
5RE7520	315	285	220	10	10	360	275	1,4
5RE7525	355	343	248	12	10	400	300	1,6
5RE7530	400	401	276	12	10	465	350	2,2
5RE7535	450	450	304	12	10	510	380	2,6

Dimensioni in mm. Pesi indicativi | Indicative weights. Dimensions in mm

RETE BOCCA ASPIRANTE | INLET GUARD

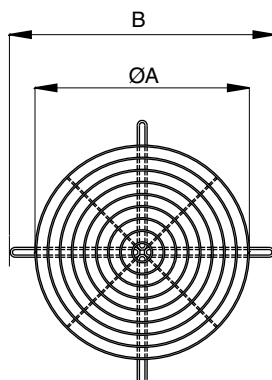

Code	Tipo Type	A	B	Kg
5RE9027	CCr25 x AL-ATX 200-225-250	200	245	0,4
5RE9032	CCr 31 x AL-ATX 280-315	320	384	0,6
5RE9036	CCr 35 x AL-ATX 355	360	434	0,8
5RE9041	CCr 40 x AL-ATX 400	400	479	0,9
5RE9046	CCr 45 x AL-ATX 450	460	529	1,1

Dimensioni in mm. Pesi indicativi | Indicative weights. Dimensions in mm